

SHIKUES Low Power Consumption, High Precision, HighESD 1-Cell Li-ion and Li-Polymer Battery Voltage and Current Protection IC

Description

- SHIKUES battery protection ICs are featured for accurately monitoring Li-ion or Li-Polymer battery voltage and current when charging and discharging the batteries. When over charge, over discharge and short circuit conditions happened, SHIKUES battery protection ICs will control the charging or discharging output pins to control charge or discharge MOSFETs to cut off the charging or discharging path accordingly to protect the batteries from being damaged.
- SHIKUES battery protection ICs monitor the charge/discharge/short circuit current by external current sensing resistor, to provide very precise current sensing control.
- SHIKUES battery protection IC embeds with high ESD protection circuit to prevent from ESD issues in mass production and in use.
- SHIKUES battery protection IC power consumption when normal operation is low. For power saving, SHIKUES battery protection IC provides 2 power saving modes : Standby mode and Power Down mode.

Features

Voltage detection and release

Overcharge Detection Voltage
Overcharge Release Voltage
Overdischarge Detection Voltage
Overdischarge Release Voltage

Current detection and release

Discharge Overcurrent Detection Voltage
Charge Overcurrent Detection Voltage
Load Short-Circuit Detection Voltage

0V Battery Charge Inhibition Battery Voltage

Operation Modes

Normal Mode	2.5uA (Typ.)	4.0uA (Max.)
Standby Mode	1.0uA (Typ.)	1.5uA (Max.)
Power Down Mode		0.1uA (Max.)

Operation Temperature Range : Ta = -40°C to +85°C

Applications

- Smart Phones
- Tablet PCs
- Handheld Data Terminals
- Portable Devices

Package Type

- DFN 1.6 x 1.6 x 0.75 (mm)

Pin Assignment

DFN 1.6 x 1.6

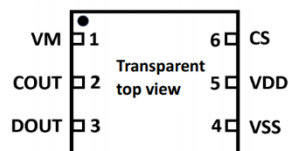

Pin No.	Symbol	Function
1	VM	Input pin for charger negative voltage
2	COUT	Charge FET Gate Drive Output
3	DOUT	Discharge FET Gate Drive Output
4	VSS	Ground
5	VDD	Input pin for positive power supply voltage
6	CS	Overcurrent detection input pin

Package Outline Drawing

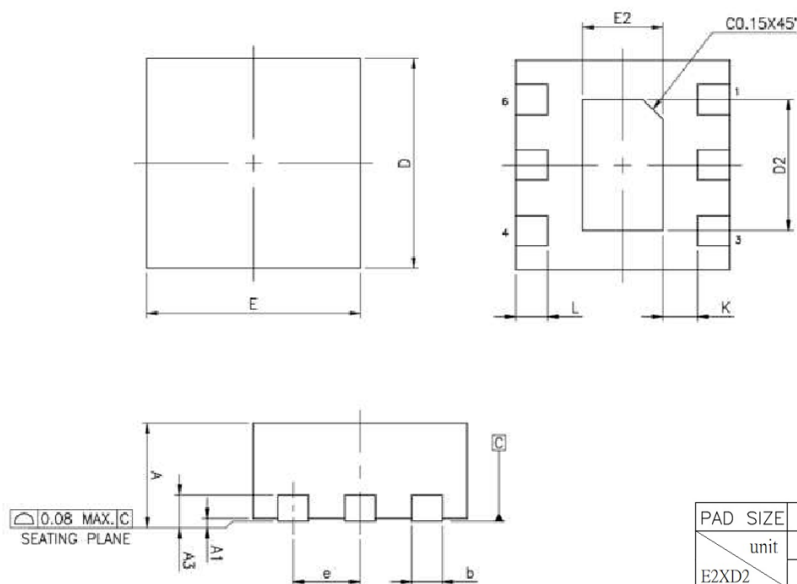

SYMBOLS	units	MIN.	NOM.	MAX.
	mm	mm	mm	mm
A	0.70	0.75	0.80	
A1	0.00	0.02	0.05	
A3	0.20 REF.			
b	0.18	0.23	0.28	
D	1.60 BSC			
E	1.60 BSC			
e	0.50 BSC			
L	0.19	0.24	0.29	
K	0.20	—	—	

PAD SIZE	E2			D2		
	MIN.	NOM.	MAX.	MIN.	NOM.	MAX.
E2XD2	mm	mm	mm	mm	mm	mm
31X47 MIL	0.55	0.60	0.65	0.95	1.00	1.05

Specifications

Absolute Maximum Ratings

Parameter	Symbol	Min	Max	Unit
Supply Voltage	VDD	-0.3	6	V
Negative Voltage Input	V _{VM}	VDD-28	VDD+0.3	V
Charge FET Control	V _{COU} T	VDD-28	VDD+0.3	V
Discharge FET Control	V _{DOU} T	-0.3	VDD+0.3	V
Current Sense Input	V _{CS}	-0.3	VDD+0.3	V
Storage Temperature	T _{stg}	-55	+125	°C

Recommend Operating Condition

Parameter	Symbol	Min	Max	Unit
Operation Temperature	T _{opr}	-40	+85	°C
Operating Voltage	V _{OP}	1.5	5.5	V

ESD Ratings

Parameter	Symbol	Value	Unit
Human Body Model	HBM	+3500	V
Machine Model	MM	+300	V
Charged Device Model	CDM	+2000	V
Latch-up		+300	mA

Product Name Structure

1. Product Name

1.1 DFN 1.6 x 1.6 x 0.75

SKPI3860 MXYZ – IAT0 A

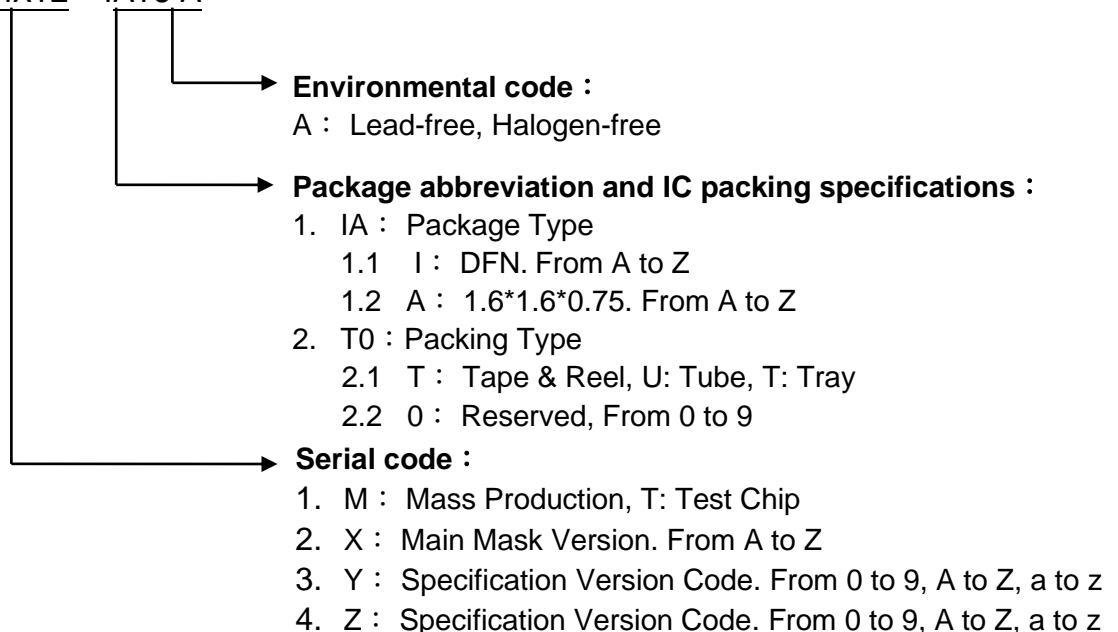

Product Line Up

Detection/Release

Part Number	Features	Overcharge Detection Voltage	Overcharge Release Voltage	Overdischarge Detection Voltage	Overdischarge Release Voltage	Discharge Overcurrent Detection Voltage	Charge Overcurrent Detection Voltage	Load Short Circuit Detection Voltage	0V Battery Charge Inhibition Battery Voltage	0V Battery Charge Permission Battery Voltage	0V Battery Charge Inhibition Battery Voltage Enable/Disable	0V Battery Charge Permission Battery Voltage Enable/Disable	Overcharge Release Voltage Latch Enable/Disable	Overcharge Release Voltage Hysteresis Enable/Disable	Power Down Mode Enable/Disable
		Vdet1	Vdet1Rel	Vdet2	Vdet2Rel	Vdet3	Vdet4	Vshort	V0INH	V0CHG	V0INH	V0CHG	Vdet1RelEn	Vdet1RelHEn	MPd
		V	V	V	V	mV	mV	mV	V	V					
SKPI3860MD001AT0A		4.475	4.275	2.5	2.9	15	-15	33	0.9	-	enable	disable	disable	enable	disable

Delay Times

Part Number	Features	Overcharge Detection Delay Time	Overcharge Release Delay Time	Overdischarge Detection Delay Time	Overdischarge Release Delay Time	Discharge Overcurrent Detection Delay Time	Discharge Overcurrent Release Delay Time	Charge Overcurrent Detection Delay Time	Charge Overcurrent Release Delay Time	Load Short Circuit Detection Delay Time
		tVdet1	tVdet1Rel	tVdet2	tVdet2Rel	tVdet3	tVdet3Rel	tVdet4	tVdet4Rel	tVshort
		s	ms	ms	ms	ms	ms	ms	ms	us
SKPI3860MD001AT0A		1.0	16	19	1.5	68	6	16	4.5	250

Electrical Characteristic

Ta=25°C, unless otherwise noted

Parameter	Test Conditions	Min	Typ	Max	Unit
Current Consumption					
I_{normal}	VDD= 3.5V, V _{CS} =0V, V _{VM} =0V		2.5	4	uA
$I_{standby}$	VDD= 1.5V, V _{CS} = 0V, V _{VM} = 1.5V		1	1.5	uA
I_{power_down}	VDD= 1.5V, V _{CS} = 0V, V _{VM} = 1.5V			0.1	uA
Resistances					
R _{VMD} : VM pin Pull-up resistance	VDD= 1.8V, V _{CS} =0V, V _{VM} =0V		312	624	kΩ
R _{VMS} : VM pin Pull-down resistance	VDD= 3.5V, V _{CS} =0V, V _{VM} =1V		23	46	kΩ
R _{COH} : COUT pin Pull-up resistance	VDD= 3.5V, V _{CS} =0V, V _{VM} =0V, V _{COUT} =3V		4.5	9	kΩ
R _{COL} : COUT pin Pull-down resistance	VDD= 4.5V, V _{CS} =0V, V _{VM} =0V, V _{COUT} =3V		3.1	6.2	kΩ
R _{DOH} : DOUT pin Pull-up resistance	VDD= 3.5V, V _{CS} =0V, V _{VM} =0V, V _{DOUT} =3V		1.6	3.2	kΩ
R _{DOL} : DOUT pin Pull-down resistance	VDD= 1.8V, V _{CS} =0V, V _{VM} =0V, V _{DOUT} =0.5V		2.1	4.2	kΩ
R _{CS} : CS pin Input resistance	VDD=3.5V, V _{CS} =0.05V, V _{VM} =0V		117	234	kΩ
0V Battery Charge Permission Function					
V _{OCHG}		0.5	0.9	1.3	V
0V Battery Charge Inhibition Function					
V _{OINH}		0.5	0.9	1.3	V

Battery Protection Accuracy

Ta=25°C, unless otherwise noted

Parameter	Symbol	Condition	Min	Typ	Max	Unit
Overcharge Detection Voltage	Vdet1		-0.015	Vdet1	+0.015	V
Overcharge Release Voltage	V _{det1Rel}		-0.020	V _{det1Rel}	+0.020	V
Overdischarge Detection Voltage	Vdet2		-0.025	Vdet2	+0.025	V
Overdischarge Release Voltage	V _{det2Rel}		-0.030	V _{det2Rel}	+0.030	V
Discharge Overcurrent Detection Voltage (Expressed as the voltage across the resistor)	Vdet3		-0.001	Vdet3	+0.001	V
Discharge Overcurrent Release Voltage	V _{det3Rel}	Release condition: VM voltage low than Discharge Overcurrent Release Voltage to release	-0.3	V _{det3Rel}	+0.3	V
Charge Overcurrent Detection Voltage (Expressed as the voltage across the resistor)	Vdet4		-0.001	Vdet4	+0.001	V
Charge Overcurrent Release Voltage	V _{det4Rel}	Release condition: VM voltage high than Charge Overcurrent Release Voltage to release	-0.1	V _{det4Rel}	+0.1	V
Load Short Circuit Detection Voltage (Expressed as the voltage across the resistor)	Vshort		-0.005	Vshort	+0.005	V
Load Short Circuit Release Voltage	V _{scRel}	Release condition: VM voltage low than to Load Short Circuit Release Voltage release	-0.3	V _{scRel}	+0.3	V
0V Battery Charge Inhibition Battery Voltage	V _{0INH}		-0.400	V _{0INH}	+0.400	V
0V Battery Charge Permission Battery Voltage	V _{0CHG}		-0.400	V _{0CHG}	+0.400	V

Battery Protection Detection & Release Delay Time Accuracy

Ta=25°C, unless otherwise noted

Parameter	Symbol	Min	Typ	Max	Unit
Overcharge Detection Delay Time	tVdet1	-30%	tVdet1	+30%	s
Overcharge Release Delay Time	tV _{det1Rel}	-30%	tV _{det1Rel}	+30%	ms
Overdischarge Detection Delay Time	tVdet2	-30%	tVdet2	+30%	ms
Overdischarge Release Delay Time	tV _{det2Rel}	-30%	tV _{det2Rel}	+30%	ms
Discharge Overcurrent Detection Delay Time	tVdet3	-30%	tVdet3	+30%	ms
Discharge Overcurrent Release Delay Time	tV _{det3Rel}	-30%	tV _{det3Rel}	+30%	ms
Charge Overcurrent Detection Delay Time	tVdet4	-30%	tVdet4	+30%	ms
Charge Overcurrent Release Delay Time	tV _{det4Rel}	-30%	tV _{det4Rel}	+30%	ms
Load Short Circuit Detection Delay Time	tVshort	-50%	tVshort	+50%	us

• Battery Protection Threshold Options

Parameter	Symbol	Options						Unit
Overcharge Detection Voltage	Vdet1	4.40	4.45	4.475	4.50	4.535	4.545	V
Overcharge Release Voltage	V _{det1Rel}	Vdet1 - 0.2V			Vdet1			V
Overdischarge Detection Voltage	Vdet2	2.1		2.3	2.36	2.4	2.5	V
Overdischarge Release Voltage (Must be over the Overdischarge Detection Voltage)	V _{det2Rel}	2.3	2.4	2.5	2.6	2.7	2.9	V
Discharge Overcurrent Detection Voltage	Vdet3	17	15	13	11	9	7	mV
Discharge Overcurrent Release Voltage	V _{det3Rel}	VDD-0.75						V
Charge Overcurrent Detection Voltage	Vdet4	-19	-17	-15	-13	-11	-9	mV
Charge Overcurrent Release Voltage	V _{det4Rel}	0.25						V
Load Short Circuit Detection Voltage	Vshort	33			31			mV
Load Short Circuit Release Voltage	V _{SCRel}	VDD-0.75						V
0V Battery Charge Inhibition Battery Voltage	V _{0INH}	1.6			0.9			V
0V Battery Charge Permission Battery Voltage	V _{0CHG}	1.6			0.9			V

• Battery Protection Detection & Release Delay Time Option ^{*1}

Parameter	Symbol	Option	Unit
Overcharge Detection Delay Time	tVdet1	1.0	s
Overcharge Release Delay Time	tV _{det1Rel}	16	ms
Overdischarge Detection Delay Time	tVdet2	19	ms
Overdischarge Release Delay Time	tV _{det2Rel}	1.5	ms
Discharge Overcurrent Detection Delay Time	tVdet3	68	ms
Discharge Overcurrent Release Delay Time	tV _{det3Rel}	6	ms
Charge Overcurrent Detection Delay Time	tVdet4	16	ms
Charge Overcurrent Release Delay Time	tV _{det4Rel}	4.5	ms
Load Short Circuit Detection Delay Time	tVshort	250	us

*1 : Current detection delay time option has only 1 option. To increase the options, please contact with Sales.

• Protection Mode Latch Enable Options

Parameter	Symbol	Options	
Overcharge Release Voltage Latch Enable/Disable	V _{det1RelEn}	Enable ^{*1}	Disable

*1 : When charge over voltage latch enabled, the overcharge control will be released when the battery voltage is lower than overcharge detection voltage and VM pin is higher than 0.25V.

• Hysteresis Enable Options

Parameter	Symbol	Options	
Overcharge Release Voltage Hysteresis Enable/Disable	V _{det1RelHEn}	Enable	Disable

• Power Down Mode Options

Parameter	Symbol	Options	
Power Down Mode Enable/Disable	M _{PD}	Enable	Disable

Typical Application Circuits

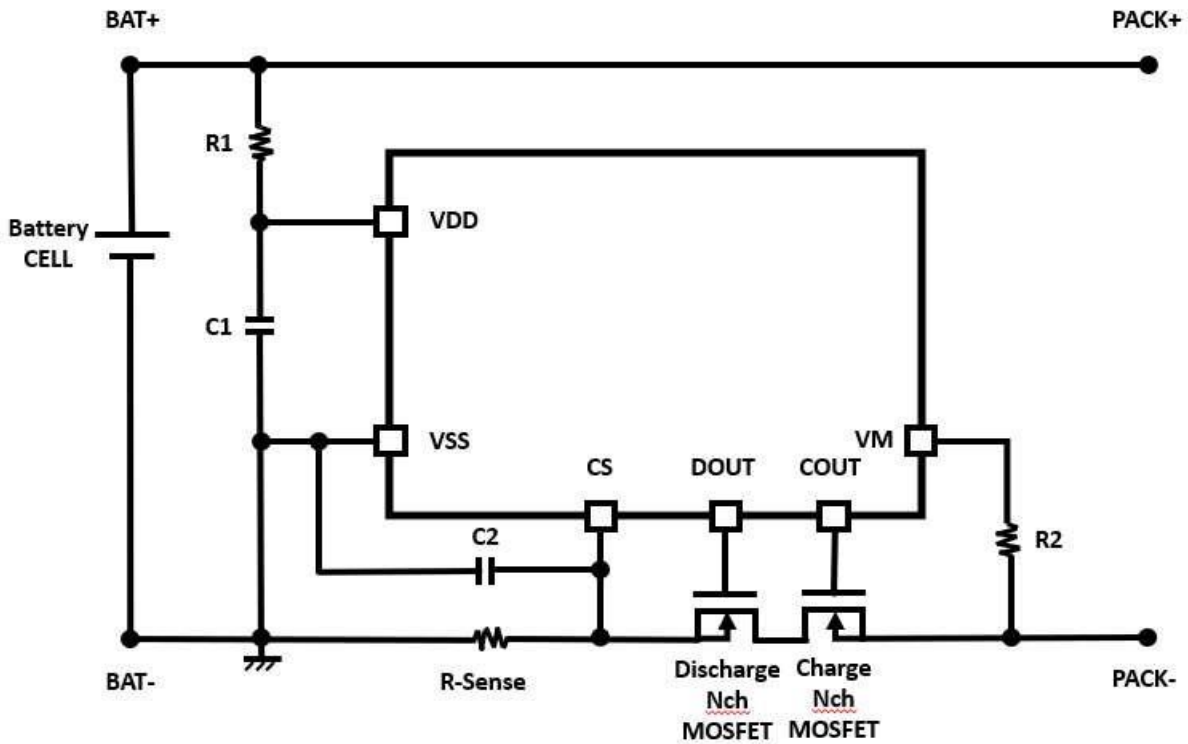

Symbol	Part	Min	Typ	Max	Unit	Purpose
R1	Resistor		100	1k	Ω	
R2	Resistor		1k	10k	Ω	For current limit of charger reverse connection
R-Sense	Resistor					
C1	Capacitor	0.01	0.1	1	uF	For Input Voltage Stability
C2	Capacitor		0.1		uF	For Noise Suppression

Test Circuits

Based on different test items, the test circuits are different and shown as below. COUT pin and DOUT pin are used as control pins to turn on or turn off the external charge and discharge MOSFETs. When COUT pin or DOUT pin is output “L”, the external MOSFET is turned off. The charge or discharge paths are cut off. At this time, charging or discharging the battery is not allowed. When the abnormal situation is released, the COUT pin or DOUT pin will output “H” to turn on the MOSFET to allow the battery to be charged or discharged. Initially, the COUT and DOUT pins are output “H” to ensure the battery can be charged or discharged. VDD pin in the test circuit can be treated as battery voltage.

1. Overcharge detection and release

The overcharge detection voltage is measured by the test circuit 1 as shown on the right.

Test steps :

1. Set VDD voltage to 3.60V and CS to 0V.
2. Increase VDD voltage gradually.
3. When the voltage on VDD is increased, exceeds the V_{det1} detection voltage and the detection delay time (tV_{det1}) expired, COUT pin will transition from "H" to "L".
4. At this moment, enter the charging overvoltage protection state.
5. Then test charging overvoltage release measurement
6. Decrease VDD voltage gradually.
7. When the voltage on VDD changes and is lower than $V_{det1Rel}$ and the delay time expired $tV_{det1Rel}$, COUT pin will transition from "L" to "H".
8. There are two conditions as below.

8.1 System connects load :

When the battery voltage is lower than V_{det1} and VM pin voltage is higher than 0.25V(typical) and the delay time expired $tV_{det1Rel}$, overcharge condition is released.

8.2 Charger remove :

When the battery voltage is lower than $V_{det1Rel}$ and VM pin voltage is lower than 0.25V(typical) and the delay time expired $tV_{det1Rel}$, overcharge condition is released.

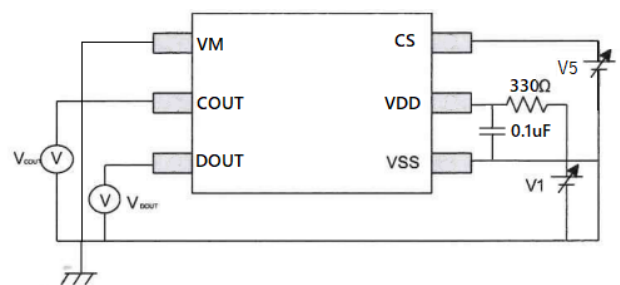

Test Circuit 1

2. Overdischarge detection and release

The overdischarge detection voltage is measured by the test circuit 2 as shown on the right.

Test steps :

1. Set VDD voltage to 3.60V and CS=VM to 0V.
2. Decrease VDD voltage gradually.
3. When the voltage on VDD is decreased, goes lower than the V_{det2} detection voltage and the detection delay time (t_{Vdet2}) expired, DOUT pin will transition from "H" to "L".
4. At this moment, enter the discharge overvoltage protection state.
5. Then test discharge overvoltage release measurement.
6. Increase VDD voltage gradually.
7. When the voltage on VDD changes and goes higher than $V_{det2Rel}$ and the delay time expired $t_{Vdet2Rel}$, DOUT pin will transition from "L" to "H".
8. At this moment, the discharge overvoltage protection state is released.

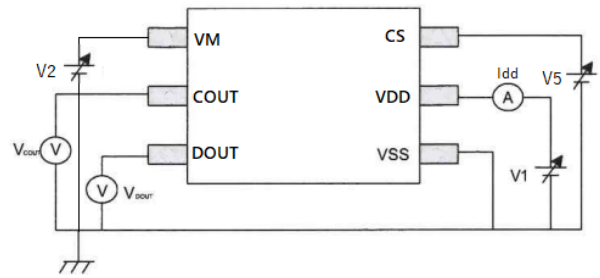

Test Circuit 2

3. Discharge overcurrent detection and release

The discharge overcurrent detection is measured by the test circuit 2 as shown on the right.

Test steps :

1. Set VDD voltage to 3.60V and CS=VM to 0V.
2. Increase CS voltage gradually.
3. When the voltage on CS pin is increased and the voltage V_{CS} is higher than VSS plus V_{det3} and the detection delay time (t_{Vdet3}) expired, DOUT pin will transition from "H" to "L".
4. At this moment, enter the discharge overcurrent protection state.
5. Then test discharge overcurrent release measurement.
6. Set $V_{CS}=0V$, $V_{VM}=3.60V$
7. Decrease VM voltage gradually.
8. For release condition : When the VM pin voltage is lower than $V_{det3Rel}$ and the release delay time expired $t_{Vdet3Rel}$.
9. Discharge overcurrent condition is released.
10. The relation between VM and Rload is shown as following :

$$V_{VM} = V_{DD} \times R_{VMS} / (R_{VMS} + R_{load})$$

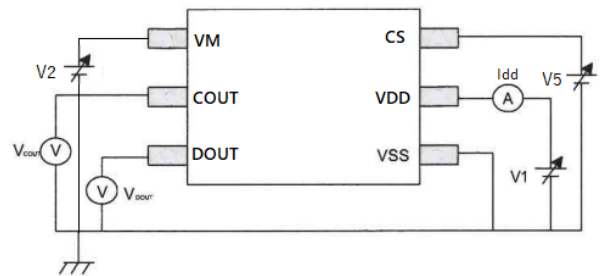

Test Circuit 2

4. Charge overcurrent detection and release

The charge overcurrent detection is measured by the test circuit 2 as shown on the right.

Test steps :

1. Set VDD voltage to 3.60V and CS=VM to 0V
2. Decrease CS voltage gradually.
3. When the voltage on CS pin is decreased and the voltage V_{CS} is lower than V_{SS} plus V_{det4} and the detection delay time (tV_{det4}) expired, COUT pin will transition from "H" to "L".
4. At this moment, enter the charging overcurrent protection state.
5. Then test charging overcurrent release measurement.
6. Set $V_{CS}=0V$
7. Increase VM voltage gradually.
8. For release condition : When the charger is removed, the system connects load, VM pin voltage is higher than $V_{det4Rel}$ and the release delay time expired $tV_{det4Rel}$. COUT pin will transition from "L" to "H".
9. Charge overcurrent condition is released.

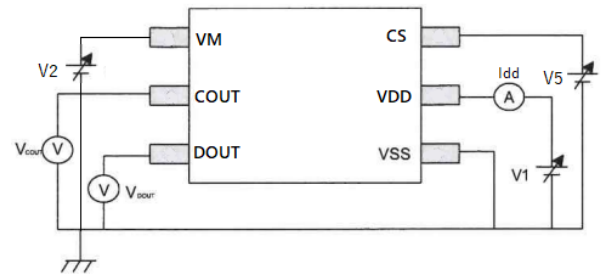

Test Circuit 2

5. Load short circuit detection and release

The load short circuit detection is measured by the test circuit 2 as shown on the right.

Test steps :

1. Set VDD voltage to 3.60V and CS=VM to 0V
2. Increase CS voltage gradually.
3. When the voltage on CS pin is increased and the voltage V_{CS} is higher than V_{short} , before the detection delay time (tV_{short}) is expired, the voltage V_{CS} keeps on increase to be higher than V_{SS} plus V_{short} and the detection delay time (tV_{short}) expired, DOUT pin will transition from "H" to "L".
4. At this moment, enter the short-circuit overcurrent protection state.
5. Then test short-circuit overcurrent release measurement.
6. Set $V_{CS}=0V$, $V_{VM}=3.60V$
7. Decrease VM voltage gradually.
8. When the VM pin voltage is lower than V_{SCRel} , DOUT pin will transition from "L" to "H".
9. Load short circuit condition is released.
10. The relation between VM and R_{load} is shown as following :

$$V_{VM} = V_{DD} \times \frac{R_{VMS}}{(R_{VMS} + R_{load})}$$

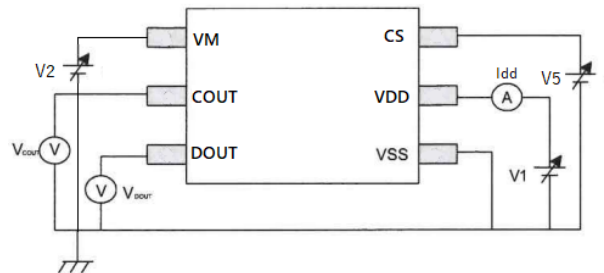

Test Circuit 2

6. Power consumption in normal operation mode

The normal mode power consumption is measured by the test circuit 2 as shown on the right.

Test steps :

1. Set VDD =3.50V
2. Set $V_{CS}=V_{VM}=0V$
3. COUT and DOUT floating.
4. Then measure the current I_{normal} going into VDD pin.
5. Get the power consumption of normal mode I_{normal}

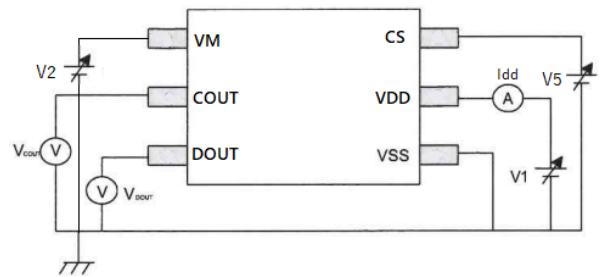

Test Circuit 2

7. Power consumption in standby mode

The standby mode power consumption is measured by the test circuit 2 as shown on the right.

Test steps :

1. Set $VDD=V_{VM}=1.50V$
2. Set $V_{CS}=0V$
3. COUT and DOUT floating.
4. Then measure the current $I_{standby}$ going into VDD pin.
5. Get The power consumption of standby mode $I_{standby}$.

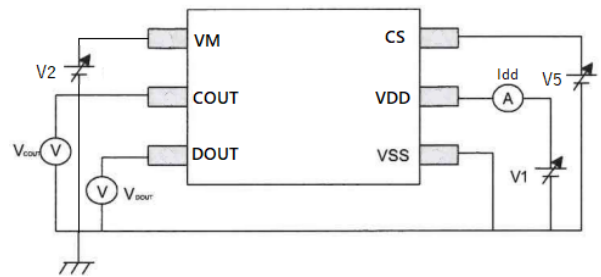

Test Circuit 2

8. Pull-up resistance between VDD to VM pin (R_{VMD})

The pull-up resistance between VDD and VM pin is measured by the test circuit 3 as shown on the right.

Test steps :

1. Set VDD=1.80V
2. Set $V_{CS}=V_{VM}=0V$
3. COUT and DOUT floating.
4. Then measure the current I_{VM} .
5. The pull-up resistance between VDD and VM pin is obtained by the relation :

$$R_{VMD}=VDD/I_{VM}$$

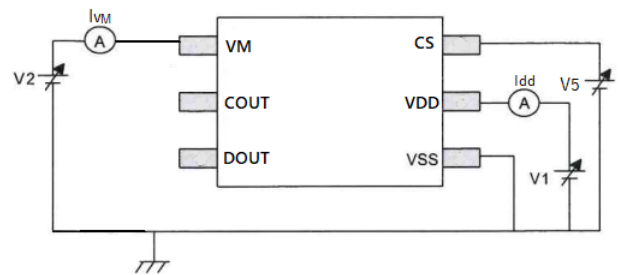

Test Circuit 3

9. Pull-down resistance between VM to VDD pin (R_{VMS})

The pull-down resistance between VDD and VM pin is measured by the test circuit 3 as shown on the right.

Test steps :

1. Set VDD=3.50V
2. Set $V_{CS}=0V$
3. Set $V_{VM}=1.0V$
4. COUT and DOUT floating.
5. Then measure the current I_{VM} .
6. The pull-down resistance between VDD and VM pin is obtained by the relation :

$$R_{VMS}=V_{VM}/I_{VM}$$

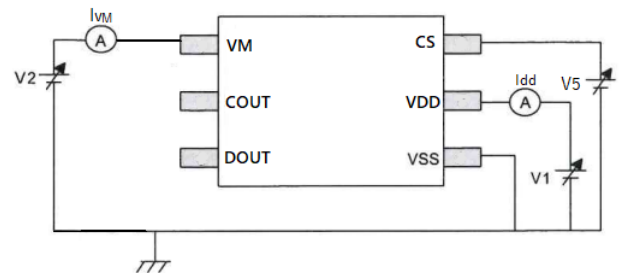

Test Circuit 3

10. COUT pin pull-up resistance (R_{COH})

The pull-up resistance on COUT pin is measured by the test circuit 4 as shown on the right.

Test steps :

1. Set $V_{DD}=3.50V$
2. Set $V_{CS}=V_{VM}=0V$
3. Set $V_{COUT}=3.0V$
4. DOUT floating
5. Then measure the current I_{COUT} .
6. The COUT pin pull-up resistance is obtained by the relation :

$$R_{COH}=(V_{DD}-V_{COUT})/I_{COUT}$$

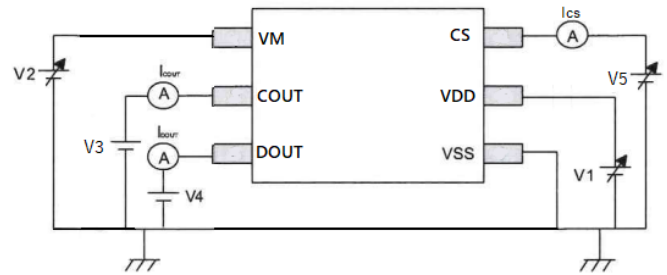

Test Circuit 4

11. COUT pin pull-down resistance (R_{COL})

The pull-down resistance on COUT pin is measured by the test circuit 4 as shown on the right.

Test steps :

1. Set $V_{DD}=4.50V$
2. Set $V_{CS}=V_{VM}=0V$
3. Set $V_{COUT}=3.0V$
4. DOUT floating
5. Then measure the current I_{COUT} .
6. The COUT pin pull-down resistance is obtained by the relation :

$$R_{COL}=V_{COUT}/I_{COUT}$$

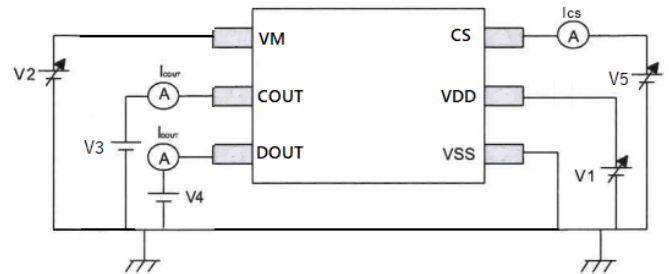

Test Circuit 4

12. DOUT pin pull-up resistance (R_{DOH})

The pull-up resistance on DOUT pin is measured by the test circuit 4 as shown on the right.

Test steps :

1. Set $V_{DD}=3.50V$
2. Set $V_{CS}=V_{VM}=0V$
3. Set $V_{DOUT}=3.0V$
4. COUT floating.
5. Then measure the current I_{DOUT} .
6. The DOUT pin pull-up resistance is obtained by the relation :

$$R_{DOH}=(V_{DD}-V_{DOUT})/I_{DOUT}$$

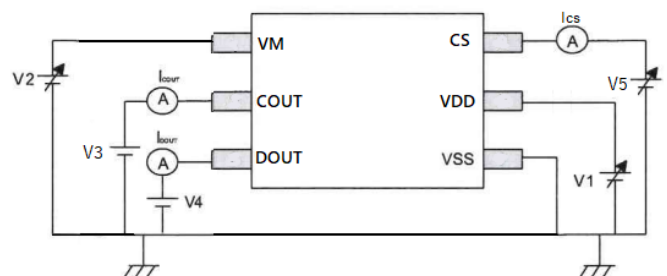

Test Circuit 4

13. DOUT pin pull-down resistance (R_{DOL})

The pull-down resistance on DOUT pin is measured by the test circuit 4 as shown on the right.

Test steps :

1. Set $V_{DD}=1.80V$
2. Set $V_{CS}=V_{VM}=0V$
3. Set $V_{DOUT}=0.50V$
4. COUT floating
5. Then measure the current I_{DOUT} .
6. The DOUT pin pull-down resistance is obtained by the relation :

$$R_{DOL} = V_{DOUT} / I_{DOUT}$$

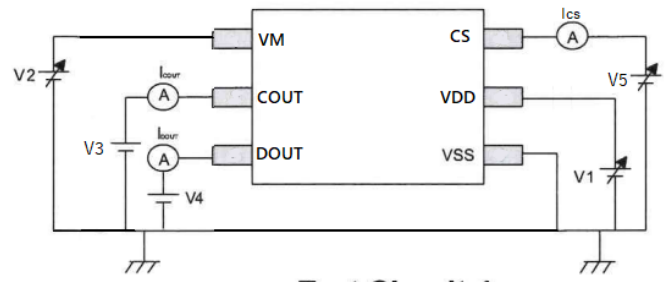

Test Circuit 4

14. CS pin input resistance (R_{CS})

The input resistance on CS pin is measured by the test circuit 4 as shown on the right.

Test steps :

1. Set $V_{DD}=3.50V$
2. Set $V_{CS}=0.05V$
3. Set $V_{VM}=0V$
4. COUT and DOUT floating.
5. Then measure the current I_{CS} .
6. The CS pin input resistance is obtained by the relation :

$$R_{CS} = V_{CS} / I_{CS}$$

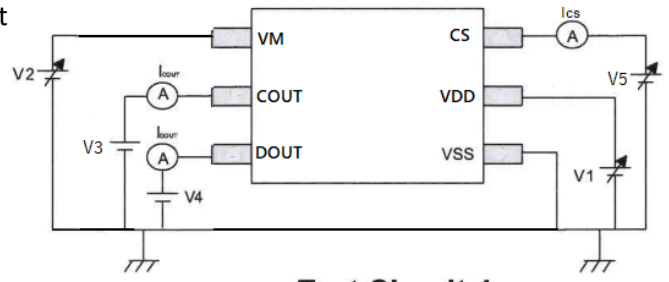

Test Circuit 4

15. 0V Battery charge inhibition voltage (V_{0INH})

The 0V battery charge inhibition voltage threshold is measured by the test circuit 2 as shown on the right.

Test steps :

1. Set $V_{DD}=V_{CS}=0V$
2. Set $V_{VM}=-4.0V$
3. DOUT floating.
4. Increase VDD voltage gradually, monitor V_{COUT} .
5. The V_{0INH} equals to the VDD once $V_{COUT} \geq V_{VM} + 0.10V$.

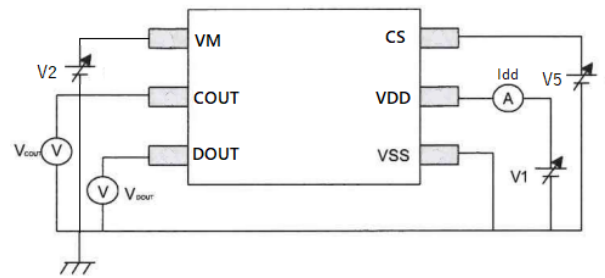

Test Circuit 2

16. 0V Battery charge permission voltage (V_{0CHG})

The 0V battery charge permission voltage threshold is measured by the test circuit 2 as shown on the right.

Test steps :

1. Set $V_{DD}=V_{CS}=0V$
2. Set $V_{VM}=0V$
3. DOUT floating.
4. Decrease VM voltage gradually, monitor V_{COUT} .
5. The V_{0CHG} equals to the | VM | once $V_{COUT} \geq V_{VM} + 0.10V$

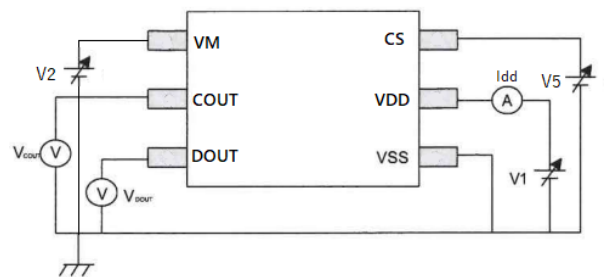

Test Circuit 2

17. Overcharge detection delay time (tVdet1)

The overcharge detection delay time is measured by the test circuit 5 as shown on the right.

Test steps :

1. Set VDD=3.50V
2. Set $V_{CS}=V_{VM}=0V$
3. DOUT floating
4. Then monitor COUT pin whether transition from "H" to "L".
5. Increase the VDD voltage. When VDD voltage exceeds the Vdet1 detection threshold, the internal delay time counter starts to count. When the internal delay time counts exceeds the tVdet1, COUT pin will transition from "H" to "L".
6. tVdet1 equals to the time period between VDD voltage exceeds Vdet1 and COUT transitions from "H" to "L".

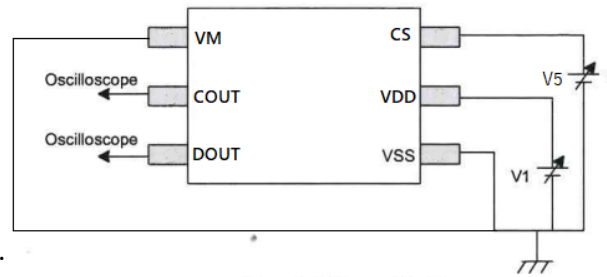

Test Circuit 5

18. Overdischarge detection delay time (tVdet2)

The overdischarge detection delay time is measured by the test circuit 5 as shown on the right.

Test steps :

1. Set VDD=3.50V
2. Set $V_{CS}=V_{VM}=0V$
3. COUT floating
4. Then monitor DOUT pin whether transition from "H" to "L".
5. Decrease the VDD voltage. When VDD voltage goes lower than the Vdet2 detection threshold, the internal delay time counter starts to count. When the internal delay time counts exceeds the tVdet2, DOUT pin will transition from "H" to "L".
6. tVdet2 equals to the time period between VDD voltage goes lower than Vdet2 and DOUT transitions from "H" to "L".

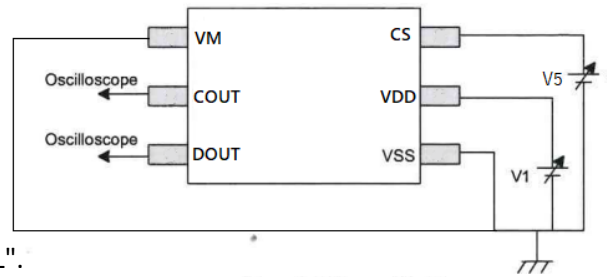

Test Circuit 5

19. Discharge overcurrent detection delay time (tVdet3)

The discharge overcurrent detection delay time is measured by the test circuit 5 as shown on the right.

Test steps :

1. Set VDD=3.50V
2. Set $V_{CS}=V_{VM}=0V$
3. COUT floating.
4. Then monitor DOUT pin whether transition from "H" to "L".
5. Increase the V_{CS} voltage. When V_{CS} voltage exceeds the Vdet3 detection threshold, the internal delay time counter starts to count. When the internal delay time counts exceeds the tVdet3, DOUT pin will transition from "H" to "L".
6. tVdet3 equals to the time period between V_{CS} voltage exceeds Vdet3 and DOUT transitions from "H" to "L".

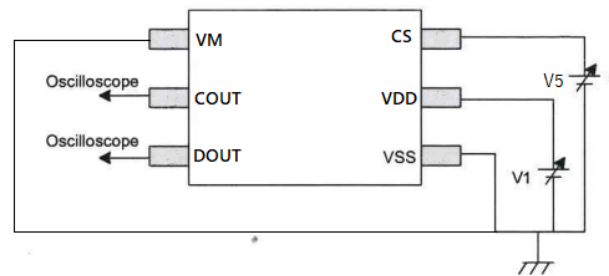

Test Circuit 5

20. Charge overcurrent detection delay time (tVdet4)

The charge overcurrent detection delay time is measured by the test circuit 5 as shown on the right.

Test steps :

1. Set VDD=3.50V
2. Set $V_{CS}=V_{VM}=0V$
3. DOUT floating.
4. Then monitor COUT pin whether transition from "H" to "L".
5. Decrease the V_{CS} voltage. When V_{CS} voltage goes lower than the Vdet4 detection threshold, the internal delay time counter starts to count. When the internal delay time counts exceeds the tVdet4, COUT pin will transition from "H" to "L".
6. tVdet4 equals to the time period between V_{CS} voltage goes lower than Vdet4 and COUT transitions from "H" to "L".

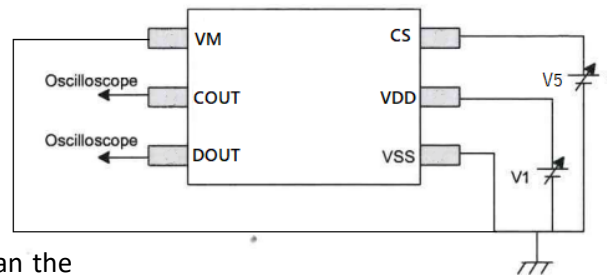

Test Circuit 5

21. Load short circuit detection delay time(tVshort)

The load short circuit detection delay time is measured by the test circuit 5 as shown on the right.

Test steps :

1. Set VDD=3.50V
2. Set $V_{CS}=V_{VM}=0V$
3. COUT floating.
4. Then monitor DOUT pin whether transition from "H" to "L".
5. Increase the V_{CS} voltage. When V_{CS} voltage exceeds the Vshort detection threshold, the internal delay time counter starts to count. When the internal delay time counts exceeds the tVshort, DOUT pin will transition from "H" to "L".
6. tVshort equals to the time period between V_{CS} voltage exceeds Vshort and DOUT transitions from "H" to "L".

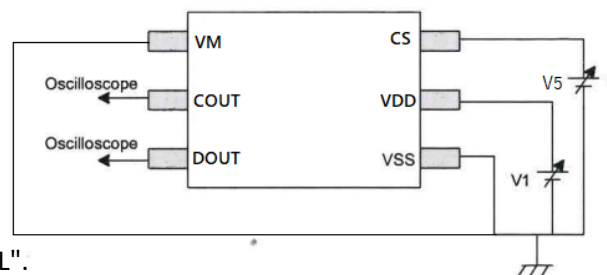

Test Circuit 5

Product Series Specification Option

SKPI3860MD Fuse Trim at CP stage Option

Features	Overcharge Detection Voltage	Overdischarge Detection Voltage	Overdischarge Release Voltage (Must be over Overdischarge Detection Voltage)	Discharge Overcurrent Detection Voltage	Charge Overcurrent Detection Voltage	Load Short Circuit Detection Voltage	Overcharge Release Voltage Latch Enable/Disable	Overcharge Release Voltage Hysteresis Enable/Disable	Power Down Mode Enable/Disable
Symbol	Vdet1	Vdet2	V _{det2Rel}	Vdet3	Vdet4	Vshort	V _{det1RelEn}	V _{det1RelHEn}	M _{PD}
Unit	V	V	V	mV	mV	mV			
Value	4.400	2.10	2.3	7	-9	31	disable	disable	disable
	4.450	2.30	2.4	9	-11	33	enable	enable	enable
	4.475	2.36	2.5	11	-13				
	4.500	2.40	2.6	13	-15				
	4.535	2.50	2.7	15	-17				
	4.545		2.9	17	-19				
			19	-21					

SKPI3860MD Metal Option at Photo

Features	0V Battery Charge Inhibition Battery Voltage	0V Battery Charge Permission Battery Voltage	0V Battery Charge Inhibition Battery Voltage Enable/Disable	0V Battery Charge Permission Battery Voltage Enable/Disable
Symbol	V _{0INH}	V _{0CHG}	V _{0INH}	V _{0CHG}
Unit	V	V		
Value	1.6	1.6	disable	disable
	0.9	0.9	enable	enable

The options in yellow color are for current SKPI3860MD00IAT0A version.