

CURRENT 2.0 Ampere
 VOLTAGE RANG 50 to 1000 Volts

KBP2005 THRU KBP210

Features

- This series is SGS listed under the Recognized Component Index, file number SZXEC1902259902
- Ideal for printed circuit board mounting
- The plastic material used carries Underwriters Laboratory flammability recognition 94V-0
- Built-in printed circuit board stand-offs
- High case dielectric strength
- High temperature soldering guaranteed 265°C/10 seconds at 5 lbs (2.3kg) tension

Mechanical Data

Case: Reliable low cost construction utilizing molded plastic technique
 Terminals: Plated leads solderable per MIL-STD-202, Method 208
 Mounting Position: Any
 Weight: 0.065 ounce, 2.2 grams (approx)

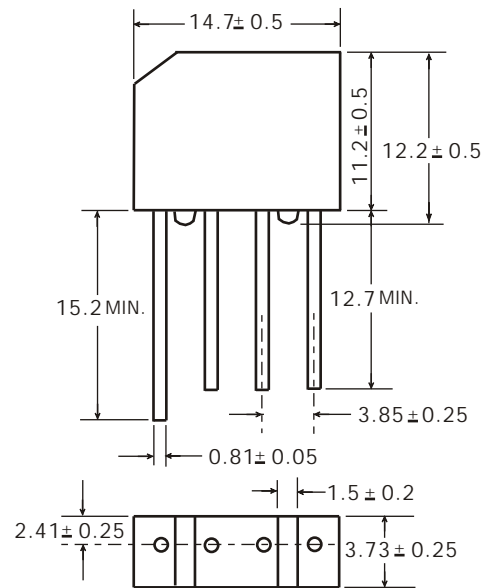

Dimensions in millimeters(1mm =0.0394")

Maximum Ratings & Thermal Characteristics

Rating at 25°C ambient temperature unless otherwise specified, Resistive or Inductive load, 60 Hz.
 For Capacitive load derate current by 20%.

Parameter	Symbol	KBP 2005	KBP 201	KBP 202	KBP 204	KBP 206	KBP 208	KBP 210	unit
Maximum repetitive peak reverse voltage	VRRM	50	100	200	400	600	800	1000	V
Maximum RMS bridge input voltage	VRMS	35	70	140	280	420	560	700	V
Maximum DC blocking voltage	VDC	50	100	200	400	600	800	1000	V
Maximum average forward rectified output current at TA=50°C	IF(AV)	2.0							A
Peak forward surge current single sine-wave superimposed on rated load (JEDEC Method)	IFSM	60							A
Rating for fusing (t<8.3ms)	I ² t	15.0							A ² sec
Typical thermal resistance per element (1)	ReJA	10.0							°C / W
Typical junction capacitance per element (2)	Cj	25.0							pF
Operating junction and storage temperature range	TJ, TSTG	-55 to + 150							°C

Electrical Characteristics

Rating at 25°C ambient temperature unless otherwise specified. Resistive or Inductive load, 60Hz.
 For Capacitive load derate by 20 %.

Parameter	Symbol	KBP 2005	KBP 201	KBP 202	KBP 204	KBP 206	KBP 208	KBP 210	Unit
Maximum instantaneous forward voltage drop per leg at 1.0A	VF	1.1							V
Maximum DC reverse current at rated TA =25°C DC blocking voltage per element TA =125°C	IR	10 500							μA

Notes: (1)Thermal resistance from Junction to Ambient on P.C.board mounting.
 (2)Measured at 2.0MHz and applied reverse voltage of 4.0 volts.

CURRENT 2.0 Ampere
 VOLTAGE RANG 50 to 1000 Volts

KBP2005 THRU KBP210

Rating and Characteristic Curves (TA=25°C Unless otherwise noted)

Fig. 1 Derating Curve for Output Rectified Current

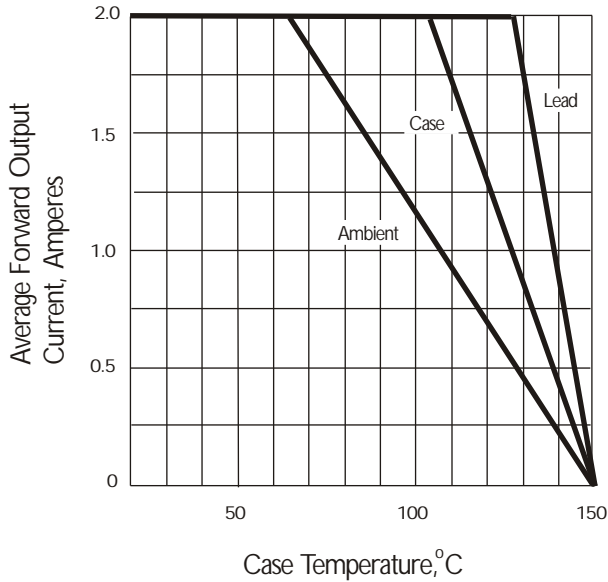

Fig. 2 Maximum Non-repetitive Peak Forward Surge Current

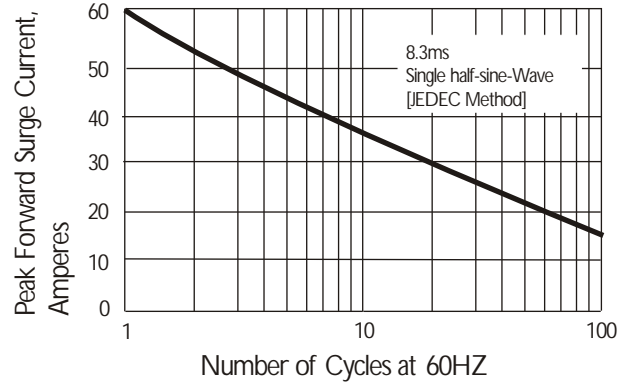

Fig. 3 Typical Instantaneous Forward Characteristics

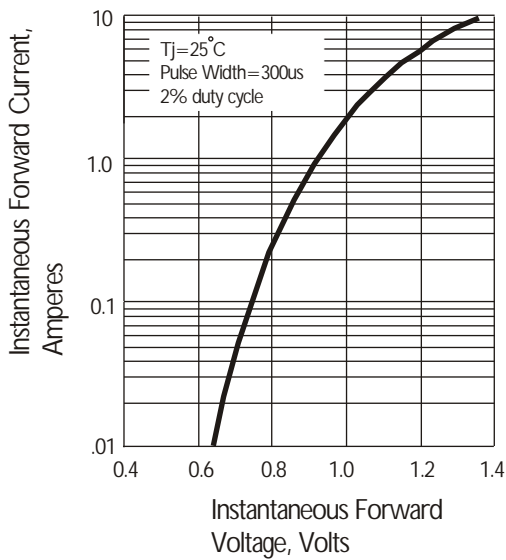

Fig. 4 Typical Reverse Characteristics

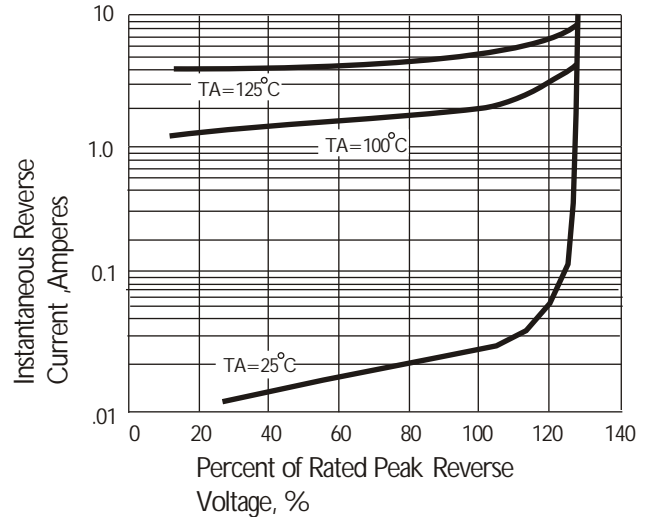

Fig. 5 Typical Junction Capacitance

