

产品规格书

SPECIFICATION

产品名称 Name.NO: 2835 紫外 UVA 0.5W 365-370nm

产品型号 Model.NO: KTR-2835UVA-365-YA05

文件编号 Document.NO:

版次 REV.NO: K4.0

描述 Description:

- 2.8×3.5×0.65mm 贴片发光二极管 2.8×3.5×0.65mm Chip SMD
- 胶体颜色 Colloid Color: 无色透明 Water Transparent
- 发光颜色 Emission Color: 紫外 UV
- 半功率角度 Viewing Angle :120°

| 深圳市科特翎科技有限公司 SHENZHEN KETERINE TECHNOLOGY CO., LTD. | | | |
|--|------------------|-------------------|---------------------|
| 编制 Prepared by | 审核 Checked by | 核准 Approved by | 市场部 Market Dept. |
| | | | |

| 客户确认 CUSTOMER CONFIRMATION | | | |
|-------------------------------|------------------|-------------------|--------------------|
| 确认 Confirmed by | 审核 Checked by | 核准 Approved by | 确认 Confirmed by |
| | | | |

1. 外形尺寸 Dimensions

单位(Units):毫米(mm)

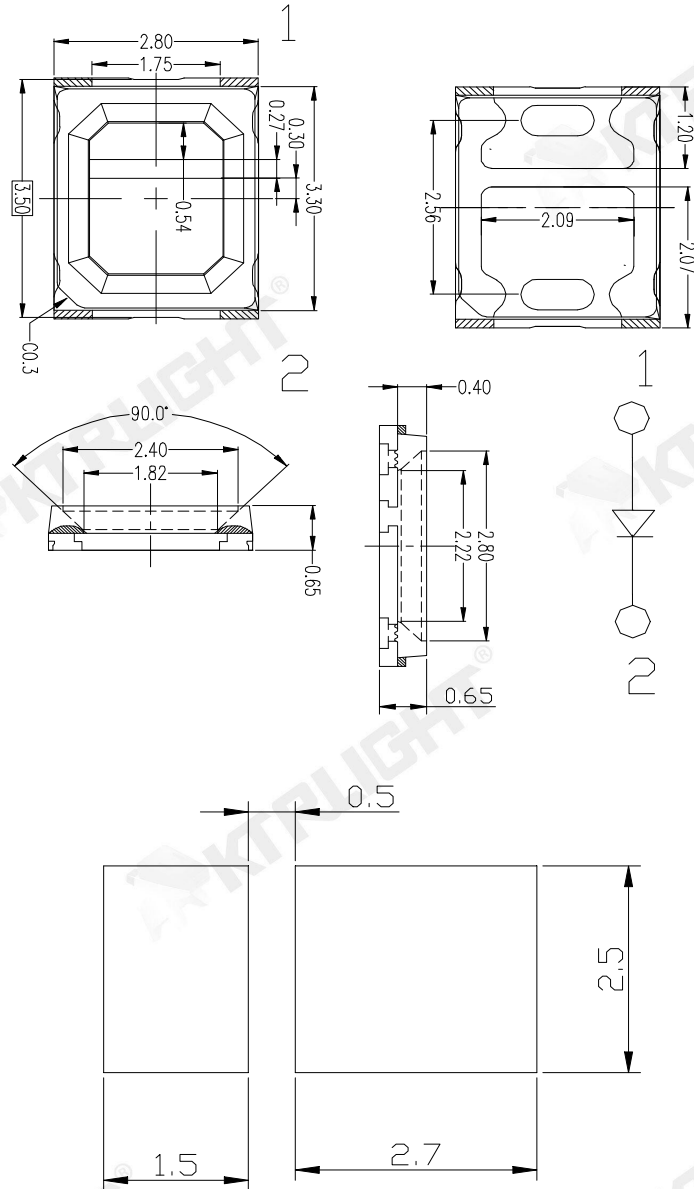

推荐焊盘式样(Recommended Soldering Patter)

注意:

所有尺寸单位为 mm ， 如无特殊说明误差范围为 ± 0.1 mm

All dimensions area in mm tolerance is ± 0.1 mm unless otherwise noted.

2. 光电特性 Electrical / Optical characteristics

(1) 最大限度值 Absolute Maximum Ratings (TA=25±5°C)

| 项目Item | 符号 Symbol | 最大额定值 Absolute Maximum Rating | 单位 Unit |
|-----------------------------|--------------|----------------------------------|------------|
| 正向电流Forward Current | IF | 150 | mA |
| 正向峰值电流Pulse Forward Current | IFP | 200 | mA |
| 反向电压Reverse Voltage | VR | 5 | V |
| 功率消耗Power Dissipation | PD | 500 | mW |
| 工作温度Operating Temperature | Topr | -25°C To +80°C | °C |
| 贮藏温度Storage Temperature | Tstg | -30°C To +85°C | °C |
| 焊接温度Soldering Temperature | Tsld | Reflow Soldering:245°C | for 10sec. |

1/10 周期, 0.1 msec 脉宽

IFP Conditions : 1/10 Duty Cycle, 0.1 msec Pulse Width.

(2) 样品光电参数 Initial Electrical/Optical Characteristics (TA=25±5°C)

| 符号 Symbol | 项目 Item | 单位 Units | 最小值 Min. | 规格值 Typ. | 最大值 Max. | 测试条件 Test Conditions |
|--------------|----------------------------|-------------|-------------|-------------|-------------|----------------------------|
| VF | 正向电压 Forward Voltage | V | 3.2 | | 3.6 | IF=150mA |
| IR | 反向电流 Reverse Current | uA | | 5 | | VR=5V |
| 2θ ½ | 发光角度 Viewing Angle | ° | | 90 | | IF=150mA |
| øIV | 光通量 luminous flux | mW | 50 | | 70 | IF=150mA |
| λ D | 主波长 Dominate Wavelength | Nm | 360 | | 370 | IF=150mA |

正向电压允许误差± 0.05V Tolerance of measurement of Vf is ±0.05 V.

亮度允许误差± 10% Luminous Intensity Measurement allowance is ± 10%.

3. 特性曲线 Characteristic curve

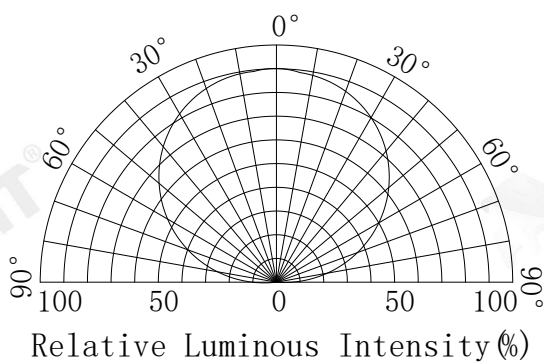
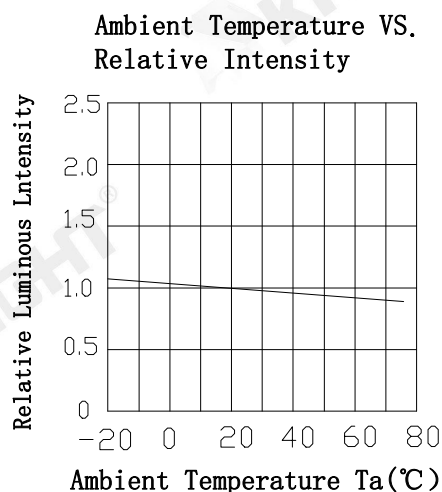
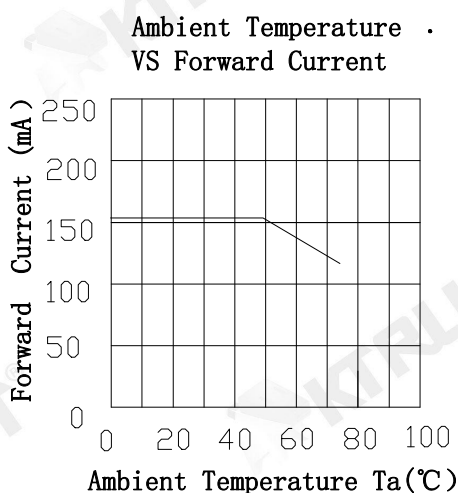
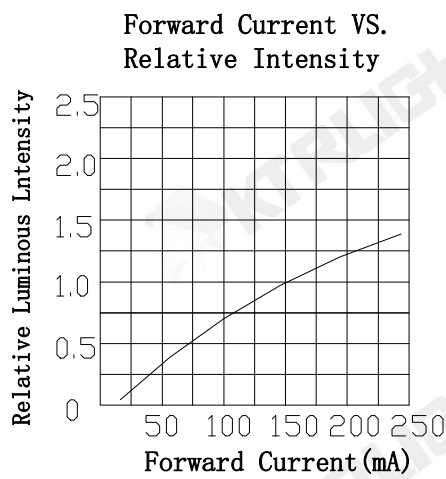
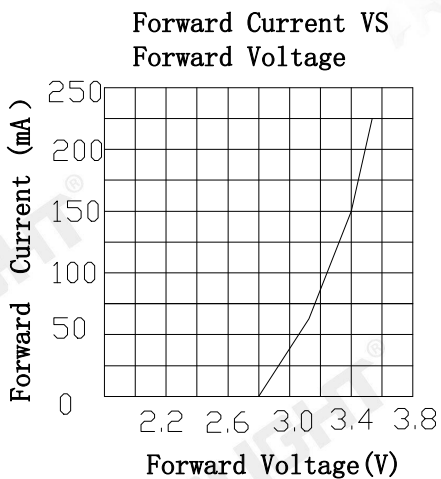

4. 可靠性 RELIABILITY

(1) 测试项目及结果 Test Items and Results

| 实验项目 Test Items | 参考标准 Reference | 实验条件 Test Conditions | 时间 Time | 样品数 Quantity | 判据 Criterion |
|--|------------------------|---|------------------------|-----------------|-----------------|
| 冷热冲击 Thermal Shock | MIL-STD-202G | -40°C(30min)←→100°C(30min) | 循环 200 次 200 cycles | 22 | 0/22 |
| 湿热循环 Temperature And Humidity Cyclic | JEITA ED-4701 200 203 | -10°C——+65°C, 0%-90%RH 24hrs./1cycle | 循环 10 次 10 cycles | 22 | 0/22 |
| 高温储存 High Temperature Storage | JEITA ED-4701 200 201 | Ta=100°C | 1000h | 22 | 0/22 |
| 低温储存 Low Temperature Storage | JEITA ED-4701 200 202 | Ta=-40°C | 1000h | 22 | 0/22 |
| 高温高湿储存 High Temperature High Humidity Storage | JEITA ED-4701 100 103 | Ta=60°C, RH=90% | 1000h | 22 | 0/22 |
| 常温寿命试验 Life Test | JESD22-A108D | Ta=25°C IF =150mA | 1000h | 22 | 0/22 |
| 高温寿命 High Temperature Life Test | JESD22-A108D | Ta=80°C IF =150mA | 1000h | 22 | 0/22 |
| 低温寿命 Low Temperature Life Test | JESD22-A108D | Ta=-40°C IF =150mA | 1000h | 22 | 0/22 |
| 耐焊接热 Resistance to Soldering Heat | GB/T 4937, II, 2.2&2.3 | Tsol*=260°C 10secs. | 2 次 2 times | 22 | 0/22 |

5. 注意事项 Cautions

(1) 焊接条件 Soldering Conditions

本产品最多只可回焊两次,且在首次回焊后须冷却至室温之后方可进行第二次回焊。

Number of reflow process shall be less than 2 times and cooling process to normal temperature is required between first and Second soldering process.

推荐焊接条件(Recommended soldering conditions)

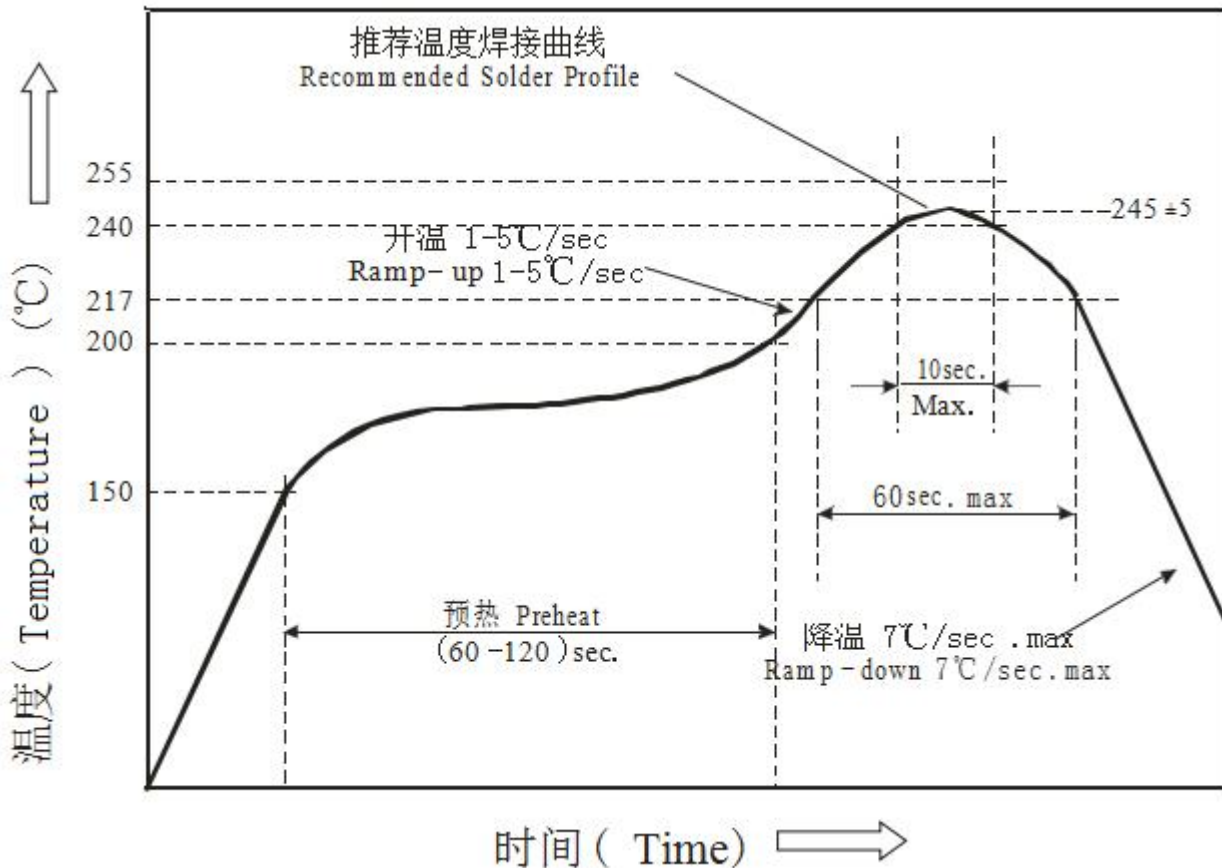

(2) 防静电措施 ESD countermeasure

静电及高压会对 LED 造成损坏,特别是晶片材质为绿色和蓝色的产品对静电防护要求更加严格,要求在使用和检验产品时戴防静电手腕带或防静电手套,焊接工具及设备外壳需可靠接地,焊接条件遵循此份规格书中的条件。

Static electricity and high volt can damage led, The production whose Die material is Green and blue must strictly required to prevent ESD, Must put on static glove and static fillet, Soldering tool and the cover of device must connect the ground, soldering condition follows the related stating of production specification manual.

(3) 过电流保护 Protecting countermeasure when over current

为避免由于电压的变化引起大电流冲击而造成产品损坏,需要加入保护电阻。

Need add the protecting resistor in circuit in order to avoid damaging led due to big current and voltage fluctuation.

(4) LED 安装方法 LED installation method

1) 注意各类器件外线的排列以防极性装错，器件不可与发热元件靠得太近，工作条件不要超过其规定的极限。

Pay attention to the led polarity and avoid installation wrong. Led can't be close to eutermic component, work condition should tally with it's specification.

2) 务必不要在引脚间距变形的情况下安装 LED。

Don't install the LED under the condition of the led pin deformation.

3) 当装配 LED 进入 PCB 或装配孔时，LED 支架不能承受任何压力。

The led bracket don't load any pressure when installing the led into PCB or fitting hole.

4) 在焊接温度回到正常以前，必须避免使 LED 受到任何的震动或外力。

Must avoid any strike and force on led before the soldering temperature return to room temperature.

(5) 存储时间 Storage time

1) 在温度 5°C~35°C，湿度 RH60%条件下，产品可保存一年。超过保存期的产品需重新检测后方可使用。

Led can be stored for a year under the condition: the temperature of 5°C~35°C and humidity of RH60%, These production must be re-inspected and tested before use if their storage time exceed a year.

2) 如果打开的产品在 5°C~35°C，RH60%的空气条件下放置超过一周，则需要将产品在 65°C±5°C的环境中放置 24 小时以上，并尽量在十五天内使用。

If led is exposed in air for a week under the condition: the temperature of 5°C~35°C, humidity of RH60%, must place the led in the ambience of 65°C±5°C for 24 hours and use it in 15 days for best.

3) 抽真空包装的产品储存超过 1-3 个月，重新使用时需烘烤 85°C/6H。

The product with vacuum packaging stored over 1-3 months, to be re-used baking 85 °C / 6H.

(6) 清洗 Cleaning

当用化学用品清洗胶体时必须特别小心，因为有些化学品对胶体表面有损伤并引起褪色如三氯乙烯、丙酮等。可用乙醇擦拭、浸渍，时间在常温下不超过 3 分钟。

Be careful of some chemical results in the led colloid fades and damage when using chemical clean the led, such as chloroethylene, acetone etc. can use ethanol to wash or soak led but the time don't exceed 3 minutes.

6. 包装 PACKAGING

- (1) LEDS 在装带之后纸箱包装. The LEDS are packed in cardboard boxes after taping.
- (2) 装带规格 Taping Specifications (单位:毫米 Units:mm)

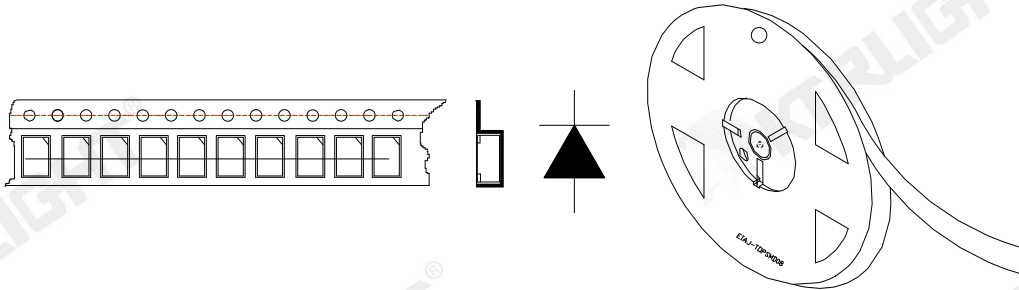

- (3) 卷轴尺寸 Reel Dimension

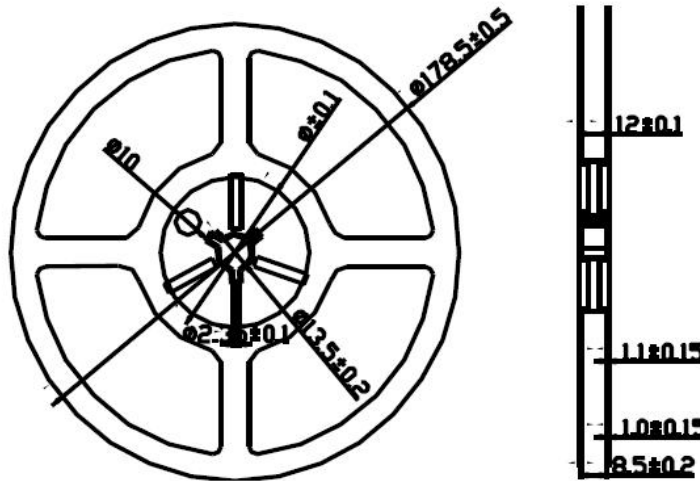

每卷数量 4000 个/卷 PACKAGE: 4000 Pcs/Reel

- (4) 最小包装标签注明以下:产品名称.批号.参数范围.数量.

The label on the minimum packing unit shows : Part Number, Lot Number, Ranking, Quantity.

- (5) 请注意防水防潮

Keep away from water, moisture in order to protect the LEDs.

- (6) 须采取适当防护措施,以防包装箱跌落或受到强力撞击造成对产品的损伤.

The LEDS may be damaged if the boxes are dropped or receive a strong impact against them. so precautions must be taken to prevent any damage.