

Description

The USBLC6-2SC6 is an ultra low capacitance TVS array, utilizing leading monolithic silicon technology to provide fast response time and low ESD clamping voltage, making this device an ideal solution for protecting voltage sensitive high-speed data lines. The USBLC6-2SC6 has an ultra-low capacitance with a typical value at 0.6 pF, and complies with the IEC 61000-4-2 (ESD) standard with $\pm 15\text{kV}$ air and $\pm 8\text{kV}$ contact discharge. It is assembled into a 6-pin lead-free SOT23-6 package. The combination of small size, ultra low capacitance, and high ESD surge capability make it ideal for use in applications such as multimedia, and other high speed ports.

Circuit Diagram

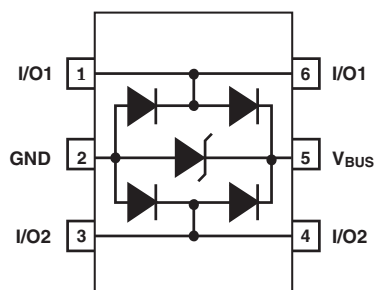

Features

- * Ultra low capacitance: 0.6 pF typical (I/O-GND)
- * Ultra low leakage: nA level
- * Low operating voltage: 5.0V
- * Up to 4 data lines and one power line protects
- * Low clamping voltage
- * Complies with following standards:
 - IEC 61000-4-2 (ESD) immunity test
Air : $\pm 20\text{kV}$; discharge: $\pm 15\text{kV}$
 - IEC61000-4-5 (Lightning) 4.5A (8/20 μs)
- * SOT23-6 Package
- * RoHS Compliant

Applications

- * Monitors and flat panel displays
- * Set-top box and Digital TV
- * Video graphics cards
- * Digital Video Interface (DVI)
- * Notebook Computers
- * PCI Express and Serial SATA Ports

Marking Diagram

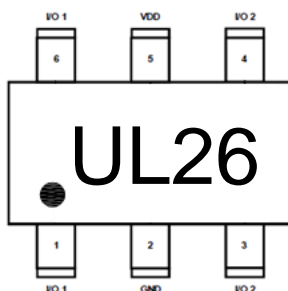

Ordering Information

Part Number	Packaging	Reel Size
USBLC6-2SC6	3000/Tape & Reel	7 inch

Absolute Maximum Ratings ($T_A=25^{\circ}\text{C}$ unless otherwise specified)

Parameter	Symbol	Value	Unit
Peak Pulse Power (8/20 μs , I/O-GND)	Ppk	60	W
Peak Pulse Power (8/20 μs , Vcc-GND)	Ppk	300	W
Peak Pulse Current (8/20 μs , I/O-GND)	IPP	4.5	A
Peak Pulse Current (8/20 μs , Vcc-GND)	IPP	17	A
ESD per IEC 61000-4-2 (Air)	$V_{\text{ESD}, \text{VDD}}$	± 20	kV
ESD per IEC 61000-4-2 (Contact)	$V_{\text{ESD}, \text{I/O}}$	± 15	
Operating Temperature Range	TJ	-55 to +125	$^{\circ}\text{C}$
Storage Temperature Range	Tstg	-55 to +150	$^{\circ}\text{C}$

Electrical Characteristics ($T_A=25^{\circ}\text{C}$ unless otherwise specified)

Parameter	Symbol	Test Condition	Min	Typ	Max	Unit
Reverse Working Voltage	V_{RWM}	Pin 5 to GND, I/O-GND			5.0	V
Breakdown Voltage	V_{BR}	$I_{\text{T}} = 1\text{mA}$ (Pin 5 to GND, I/O-GND)	6.0	7.5	8.5	V
Reverse Leakage Current	I_{R}	$V_{\text{RWM}} = 5.0\text{V}$			0.5	μA
Forward Breakdown Voltage	V_{F}	$I_{\text{F}} = 15\text{mA}$, GND to Pin 5/IO		0.8	1.0	V
Clamping Voltage	V_{C}	IPP = 4.5A (8 x 20 μs pulse, I/O to GND)		14.0	15.0	V
Clamping Voltage	V_{C}	IPP = 17A (8 x 20 μs pulse, Pin 5 to GND)		16.0	18.0	V
Junction Capacitance	C_{J}	$V_{\text{pin5}} = 5\text{V}$, I/O=0V, $f = 1\text{MHz}$, I/O-GND		0.6	0.7	pF
Junction Capacitance	C_{J}	$V_{\text{pin5}} = 5\text{V}$, I/O=0V, $f = 1\text{MHz}$, I/O-I/O pins		0.3	0.4	pF

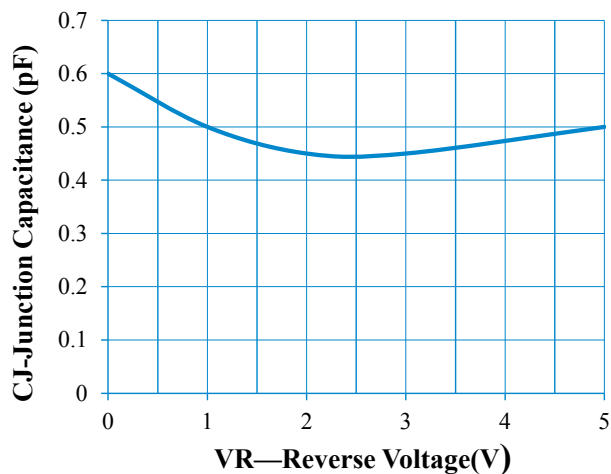
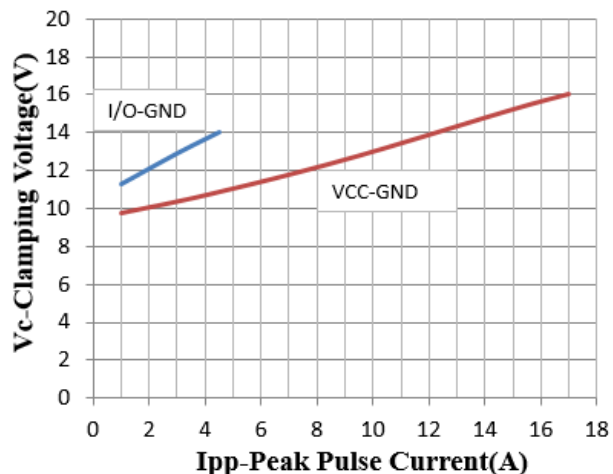
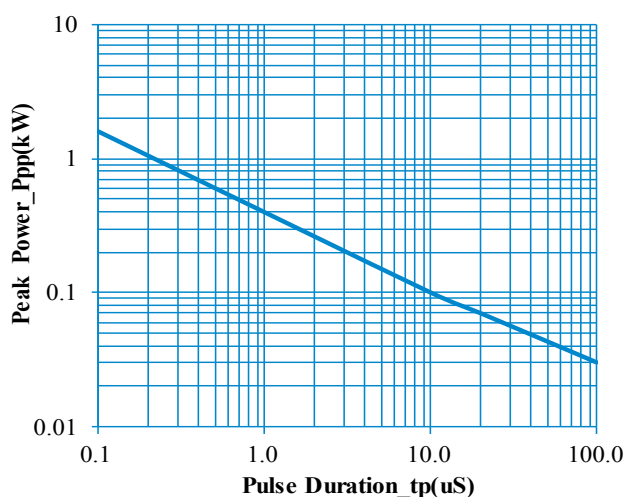
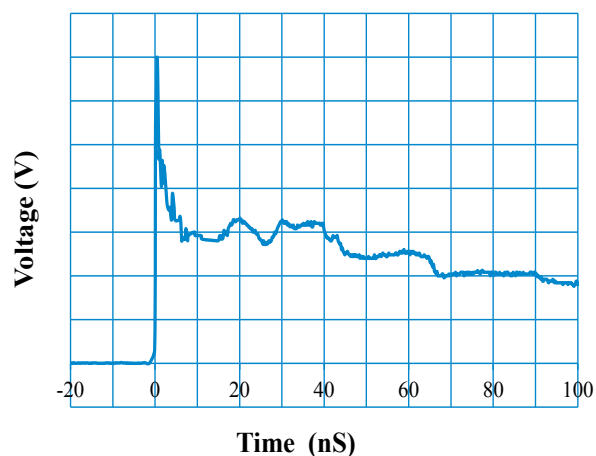
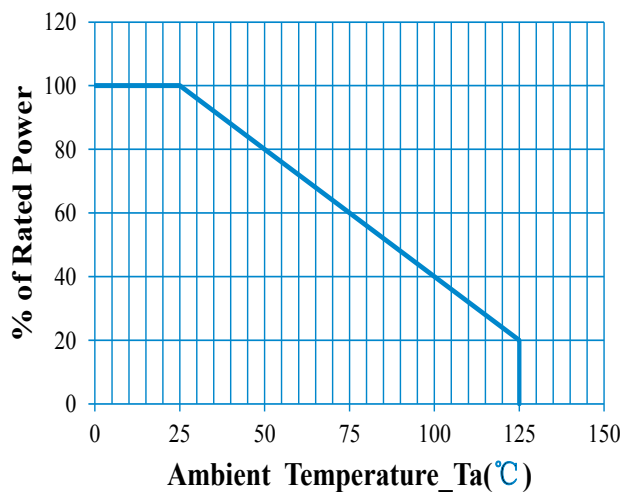
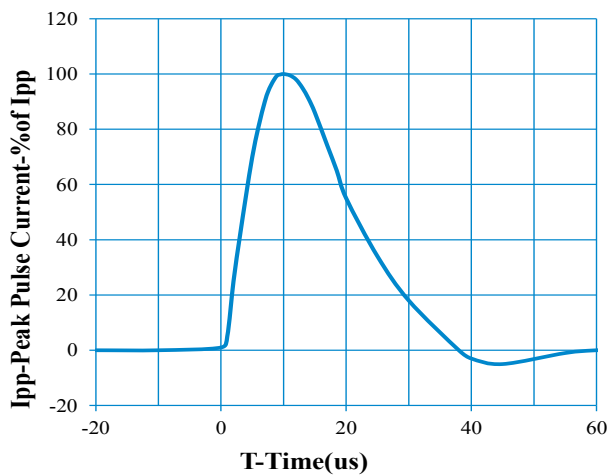
Typical Performance Characteristics ($T_A=25^{\circ}\text{C}$ unless otherwise Specified)

Junction Capacitance vs. Reverse Voltage

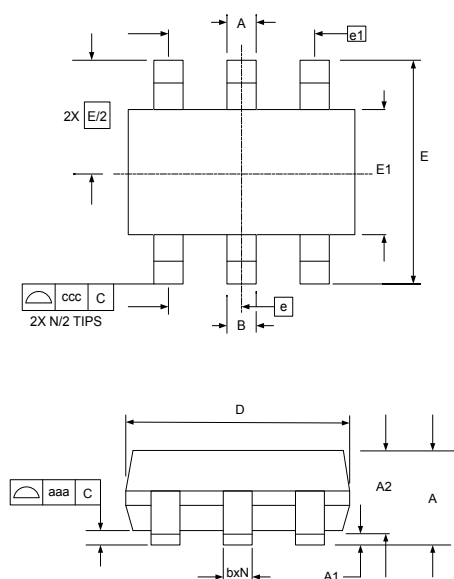
Clamping Voltage vs. Peak Pulse Current

Peak Pulse Power vs. Pulse Time

IEC61000-4-2 Pulse Waveform

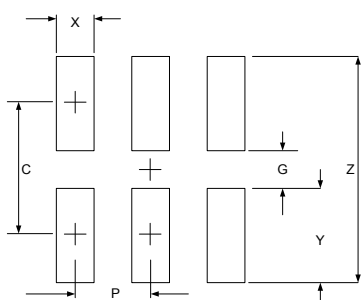
Power Derating Curve

8 X 20us Pulse Waveform

SOT23-6 Package Outline Drawing



SYM	DIMENSIONS					
	MILLIMETERS			INCHES		
	MIN	NOM	MAX	MIN	NOM	MAX
A	0.90		1.45	0.035		0.057
A1	0.00		0.15	0.000		0.006
A2	0.90	1.15	1.30	0.035	0.045	0.051
b	0.25		0.50	0.010		0.020
c	0.08		0.22	0.003		0.009
D	2.80	2.90	3.10	0.110	0.114	0.122
E1	1.50	1.60	1.75	0.060	0.063	0.069
E	2.80 BSC			0.110 BSC		
e	0.95 BSC			0.037 BSC		
e1	1.90 BSC			0.075 BSC		
N	6			6		
aaa	0.10			0.004		
ccc	0.20			0.008		

Suggested Land Pattern



SYM	DIMENSIONS	
	MILLIMETERS	INCHES
C	2.50	0.098
G	1.40	0.055
P	0.95	0.037
X	0.60	0.024
Y	1.10	0.043
Z	3.60	0.141