

Product Specification

GOODARK Type
MBR20200CT

Construction : Schottky Barrier Rectifier
Application : For General Purpose
(Manufacturer) :
Suzhou Goodark Electronics Co.,Ltd
Prepared on Sep. 17th, 2008
Prepared: R & D Department
Approval: QRA Department

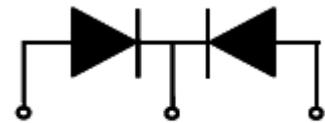
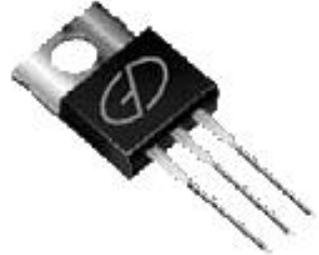

1. Anode 2. Cathode 3. Anode

SCHOTTKY BARRIER RECTIFIER
20 AMPERES
200 VOLTS

CONTENTS

1. Package Outline
2. Marking
3. Features& Mechanical Characteristics
4. Maximum Ratings and Electrical Characteristics
5. Rating and characteristic Curves
6. Packing Specification PACKAGING SPECIFICATION
7. Description of Box Label

1. Package Outline (TO220-3L)

UNIT:mm

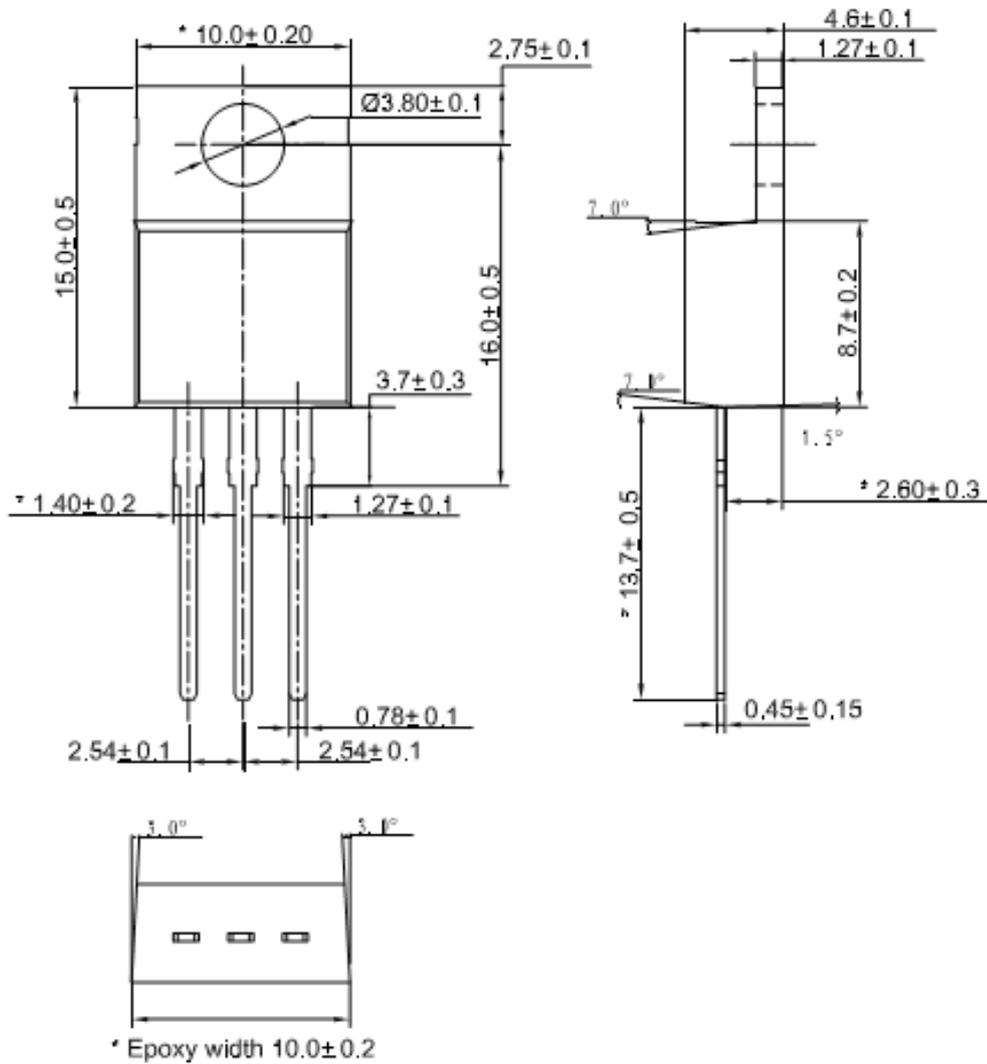

Lead Frame Material : Copper Plating: Pure Tin Plating

2.MARKING

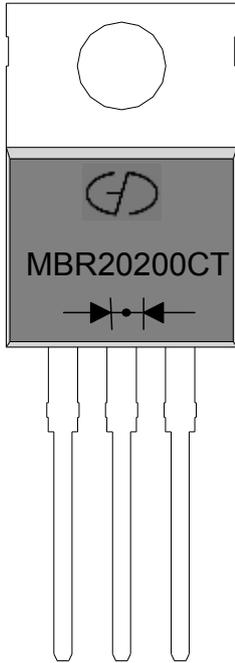

1. Part Name : MBR20200CT

2. Logo Mark:

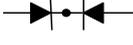

3. Polarity: 



3.Features& Mechanical Characteristics

Features

- Plastic package has underwriters Laboratory Flammability Classification 94V-0
- Dual rectifier construction, positive center tap
- Metal of silicon rectifier, majority carrier conduction
- Low forward voltage, high efficiency
- Guarding for over voltage protection
- For use in low voltage, high frequency inverters,
- Free wheeling, and polarity protection applications

Mechanical Characteristics

- Case: Epoxy, Molded
- Weight: 1.9grams (approximately)
- Finish: All External Surfaces Corrosion Resistant and Terminal Leads are Readily Solderable
- Lead Temperature for Soldering Purposes: 260°C Max.for10 sec
- Shipped 50 units per plastic tube

4.Maximum Ratings and Electrical Characteristics

MAXIMUM RATINGS and ELECTRICAL CHARACTERISTICS(TC=25°C unless otherwise moted)					
PARAMETER	TEST CONDITIONS		SYMBOL	MBR2020CT	UNIT
Maximum repetitive peak reverse voltage			VRRM	200	V
Working peak reverse voltage			VRWM	200	V
Maximum DC blocking voltage			VDC	200	V
Maximum average forward rectified current at Tc=105°C total device per diode			IF(AV)	20 10	A
Peak forward surge current 8.3ms single half sine-wave superimposed on rated load per diode			IFSM	200	A
Peak repetitive reverse current per leg at tp=2.0us , 1KHz			IRRM	1.0	A
Voltage rate of change (rated VR)			DV/dt	10000	V/us
Operating junction temperature range			TJ	-55 to+150	°C
Storage temperature range			TSTG	-55 to+150	°C
Isolation voltage (TO220F-AB only) from terminal to heatsink t = 1 sec			VAC	1500	V
Maximum instantaneous forward voltage per leg	IF=10A IF=10A	TC=25°C TC=125°C	VF	0.94 0.85	V
Maximum reverse current per leg at working peak Reverse voltage	TJ=25°C TJ=100°C		IR	200 15	uA mA

Thermal Characteristics Ta=25°C unless otherwise noted

Symbol	Parameter	Max	Unit
RθJC	Thermal Resistance, Junction to Case per Leg	2.0	°C /W
RθJA	Thermal Resistance, Junction to Ambient per Leg	62.5	°C /W

Note:

1. Screw mounting with 4-40 screw, where washer diameteris≤4.9mm(0.19 ")
2. Pulse test:300us pulse width,1% duty cycle

5. Rating and Characteristic Curves

($T_c=25^{\circ}\text{C}$ Unless otherwise noted)

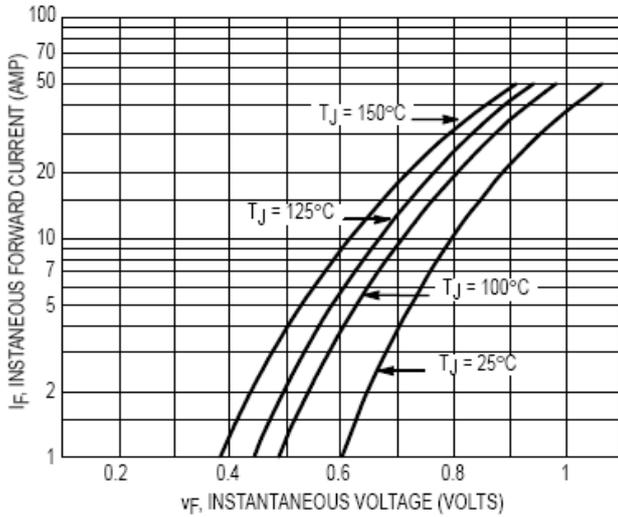

Figure 1. Typical Forward Voltage (Per Leg)

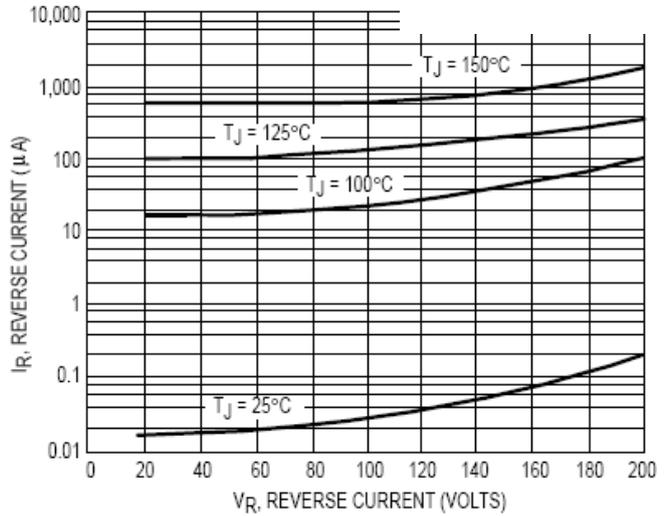

Figure 2. Typical Reverse Current (Per Leg)

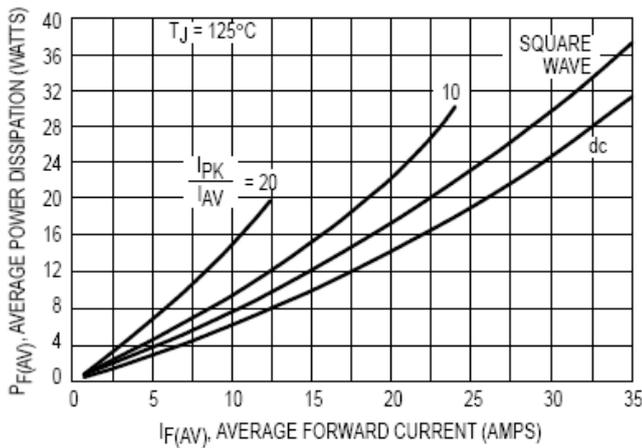

Figure 3. Forward Power Dissipation

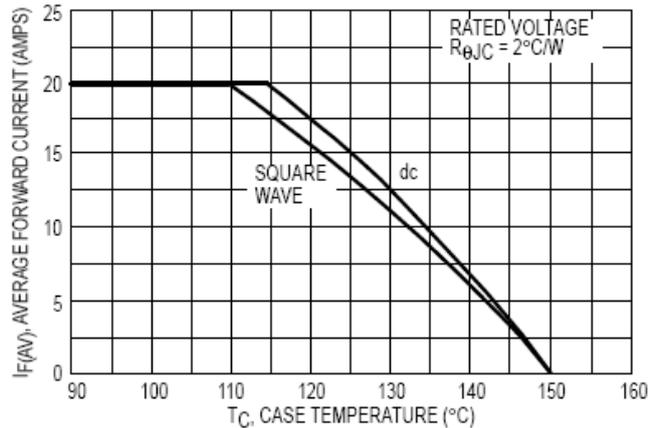

Figure 4. Current Derating, Case

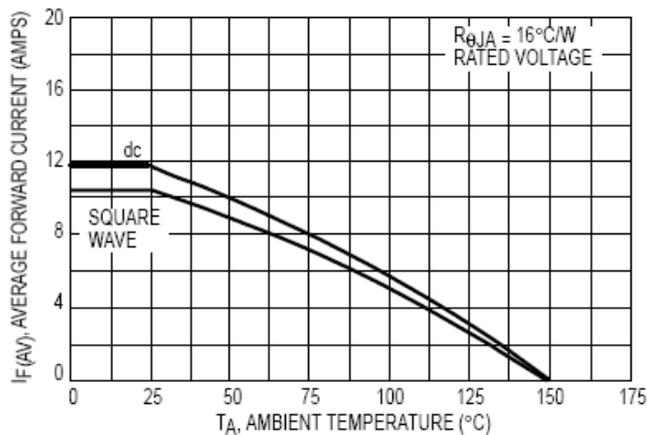

Figure 5. Current Derating, Ambient

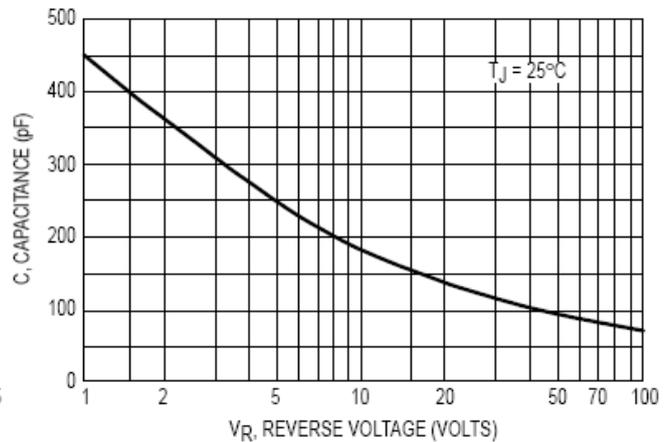
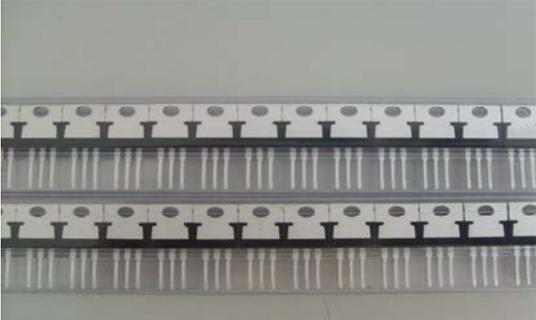
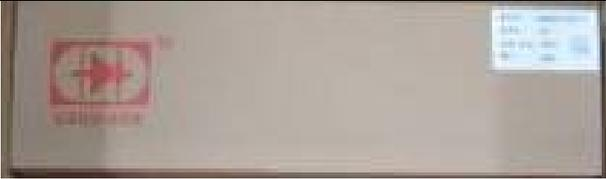

Figure 6. Typical Capacitance (Per Leg)

6. Packing Specification

	
<p>1) Tube : 50units</p>	<p>2) Inner Box: 20 tube(1000units)</p>
	
<p>3) Outer Box: 10 inner box (10,000units)</p>	

7. DESCRIPTION of BOX LABEL

	<p>TYPE: Q'TY: P/O NO: LOT NO:</p>
<p>1) Inner Box Label</p>	<p>2) Inner Box Label</p>
	<p>TYPE: Q'TY: P/O NO:</p>
<p>3) Outer Box Label</p>	<p>4) Outer Box Label</p>