

Darlington 2SD2390

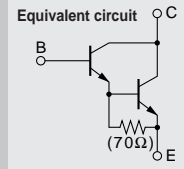

Silicon NPN Triple Diffused Planar Transistor (Complement to type 2SB1560)

Application : Audio, Series Regulator and General Purpose

Absolute maximum ratings (Ta=25°C)

| Symbol | Ratings | Unit |
|------------------|---------------------------|------|
| V _{CB0} | 160 | V |
| V _{CE0} | 150 | V |
| V _{EB0} | 5 | V |
| I _C | 10 | A |
| I _B | 1 | A |
| P _C | 100(T _C =25°C) | W |
| T _J | 150 | °C |
| T _{stg} | -55 to +150 | °C |

Electrical Characteristics (Ta=25°C)

| Symbol | Conditions | Ratings | Unit |
|----------------------|---|----------|------|
| I _{CB0} | V _{CB} =160V | 100max | μA |
| I _{EB0} | V _{EB} =5V | 100max | μA |
| V(BR) _{CEO} | I _C =30mA | 150min | V |
| h _{FE} | V _{CE} =4V, I _C =7A | 5000min* | |
| V _{CE(sat)} | I _C =7A, I _B =7mA | 2.5max | V |
| V _{BE(sat)} | I _C =7A, I _B =7mA | 3.0max | V |
| f _T | V _{CE} =12V, I _E =-2A | 55typ | MHz |
| COB | V _{CB} =10V, f=1MHz | 95typ | pF |

External Dimensions MT-100(TO3P)

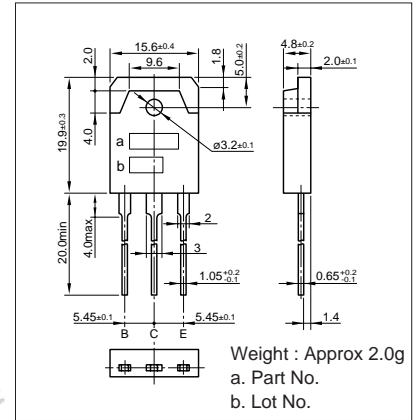

Typical Switching Characteristics (Common Emitter)

| V _{CC} (V) | R _L (Ω) | I _C (A) | V _{BB1} (V) | V _{BB2} (V) | I _{B1} (mA) | I _{B2} (mA) | t _{on} (μs) | t _{stg} (μs) | t _f (μs) |
|---------------------|--------------------|--------------------|----------------------|----------------------|----------------------|----------------------|----------------------|-----------------------|---------------------|
| 70 | 10 | 7 | 10 | -5 | 7 | -7 | 0.5typ | 10.0typ | 1.1typ |

I_C-V_{CE} Characteristics (Typical)

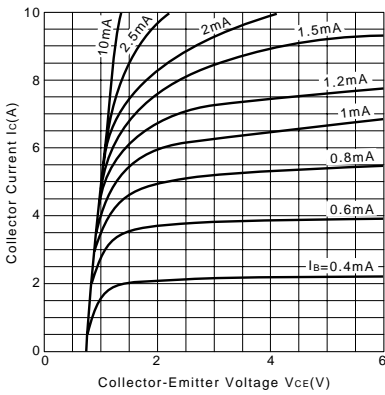

V_{CE(sat)}-I_B Characteristics (Typical)

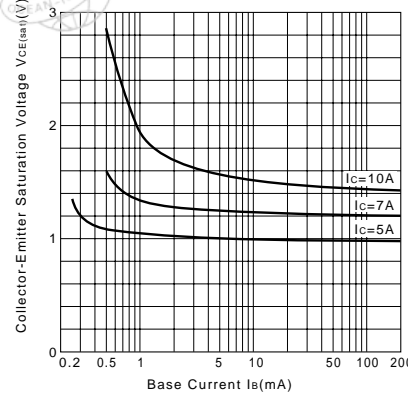

I_C-V_{BE} Temperature Characteristics (Typical)

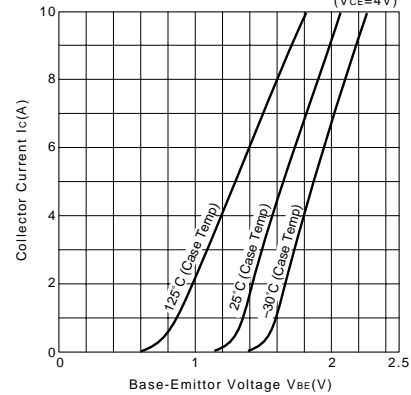

h_{FE}-I_C Characteristics (Typical)

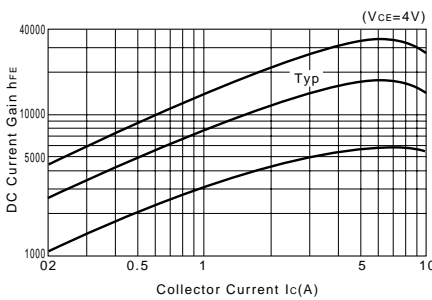

h_{FE}-I_C Temperature Characteristics (Typical)

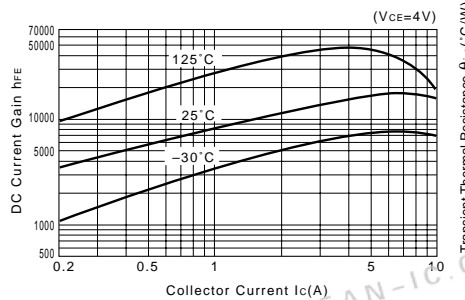

θ_{j-a-t} Characteristics

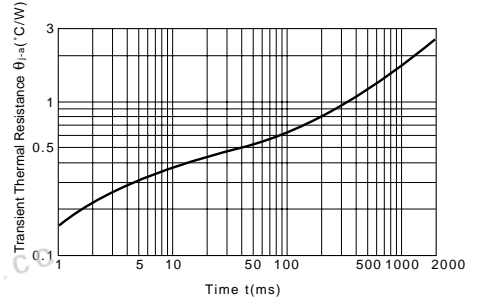

f_T-I_E Characteristics (Typical)

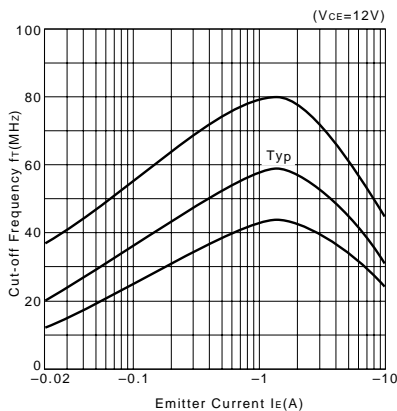

Safe Operating Area (Single Pulse)

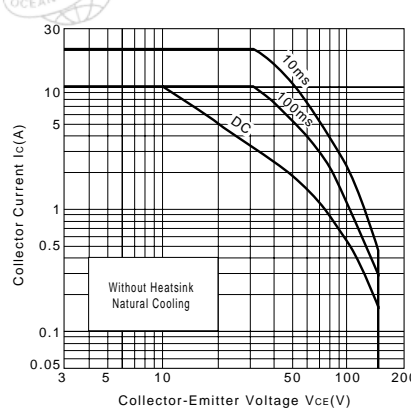

P_C-T_a Derating

