

UMW AO3402A N-Channel MOSFET

$V_{(BR)DSS}$	$R_{DS(on)MAX}$	$I_D$
30V	55 mΩ @10V	4A
	70 mΩ @4.5V	
	110 mΩ @2.5V	

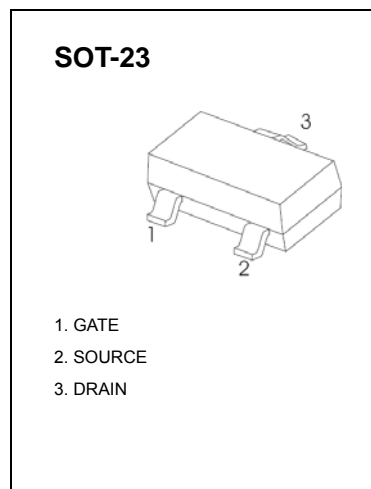

**DESCRIPTION**

The 3402 uses advanced trench technology to provide excellent  $R_{DS(ON)}$ , low gate charge and operation with gate voltage as low as 2.5V. This device is suitable for use as a load switch or in PWM application.

**FEATURES**

- Lead free product is acquired
- Surface mount package

**APPLICATION**

- Load Switch and in PWM applications

**MARKING**



**Equivalent Circuit**

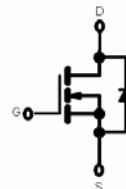

**Maximum ratings ( $T_a=25^{\circ}C$  unless otherwise noted)**

Parameter	Symbol	Value	Unit
Drain-Source Voltage	$V_{DS}$	30	V
Gate-Source Voltage	$V_{GS}$	±12	V
Continuous Drain Current	$I_D$	4	A
Pulsed Drain Current (note 1)	$I_{DM}$	15	A
Power Dissipation	$P_D$	0.35	W
Thermal Resistance from Junction to Ambient (note 2)	$R_{\theta JA}$	357	$^{\circ}C/W$
Junction Temperature	$T_J$	150	$^{\circ}C$
Storage Temperature	$T_{STG}$	-55~+150	$^{\circ}C$

**T<sub>a</sub>=25 °C unless otherwise specified**

Parameter	Symbol	Test Condition	Min	Typ	Max	Unit
<b>STATIC CHARACTERISTICS</b>						
Drain-source breakdown voltage	V <sub>(BR)DSS</sub>	V <sub>GS</sub> = 0V, I <sub>D</sub> =250μA	30			V
Zero gate voltage drain current	I <sub>DSS</sub>	V <sub>DS</sub> =24V, V <sub>GS</sub> = 0V			1	μA
Gate-body leakage current	I <sub>GSS</sub>	V <sub>GS</sub> =±12V, V <sub>DS</sub> = 0V			100	nA
Gate threshold voltage (note 3)	V <sub>GS(th)</sub>	V <sub>DS</sub> =V <sub>GS</sub> , I <sub>D</sub> =250μA	0.6		1.4	V
Drain-source on-resistance (note 3)	R <sub>DS(on)</sub>	V <sub>GS</sub> =10V, I <sub>D</sub> =4A			55	mΩ
		V <sub>GS</sub> =4.5V, I <sub>D</sub> =3A			70	mΩ
		V <sub>GS</sub> =2.5V, I <sub>D</sub> =2A			110	mΩ
Forward transconductance (note 3)	g <sub>FS</sub>	V <sub>DS</sub> =15V, I <sub>D</sub> =4A		8		S
Diode forward voltage (note 3)	V <sub>SD</sub>	I <sub>S</sub> =1A, V <sub>GS</sub> = 0V			1	V
<b>DYNAMIC CHARACTERISTICS (note 4)</b>						
Input capacitance	C <sub>iss</sub>	V <sub>DS</sub> =15V, V <sub>GS</sub> =0V, f =1MHz		390		pF
Output capacitance	C <sub>oss</sub>			54.5		pF
Reverse transfer capacitance	C <sub>rss</sub>			41		Pf
Gate resistance	R <sub>g</sub>	V <sub>DS</sub> =0V, V <sub>GS</sub> =0V, f =1MHz		3		Ω
<b>SWITCHING CHARACTERISTICS (note 4)</b>						
Turn-on delay time	t <sub>d(on)</sub>	V <sub>GS</sub> =10V, V <sub>DS</sub> =15V, R <sub>L</sub> =3.75Ω, R <sub>GEN</sub> =6Ω		3.3		ns
Turn-on rise time	t <sub>r</sub>			1		ns
Turn-off delay time	t <sub>d(off)</sub>			21.7		ns
Turn-off fall time	t <sub>f</sub>			2.1		ns
Total gate charge	Q <sub>g</sub>	V <sub>DS</sub> =15V, V <sub>GS</sub> =4.5V, I <sub>D</sub> =4A		4.34		nC
Gate-source Charge	Q <sub>gs</sub>			0.6		nC
Gate-drain Charge	Q <sub>gd</sub>			1.38		nC
Body diode reverse recovery time	t <sub>r</sub>	I <sub>F</sub> =4A, di/dt=100A/μs		1.2		ns
Body diode reverse recovery charge	Q <sub>rr</sub>			6.3		nC

**Notes :**

1. Repetitive rating : Pulse width limited by junction temperature.
2. Surface mounted on FR4 board , t<sub>s</sub>≤10s.
3. Pulse Test : Pulse Width≤80μs, Duty Cycle≤0.5%.
4. Guaranteed by design, not subject to producing.

■ Typical Characteristics

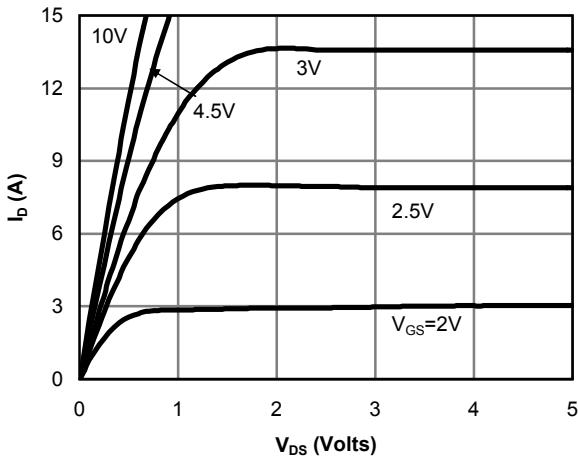

Fig 1: On-Region Characteristics

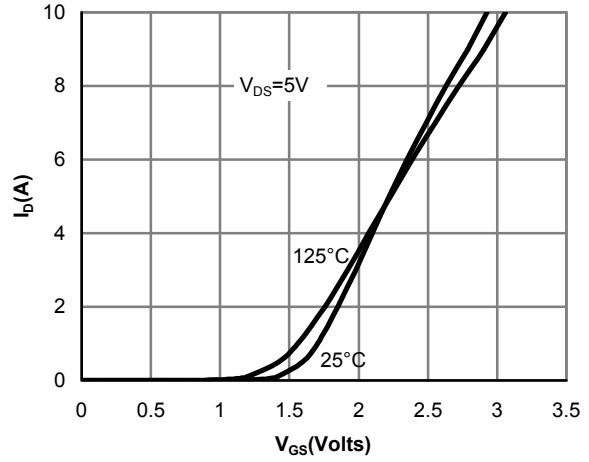

Figure 2: Transfer Characteristics

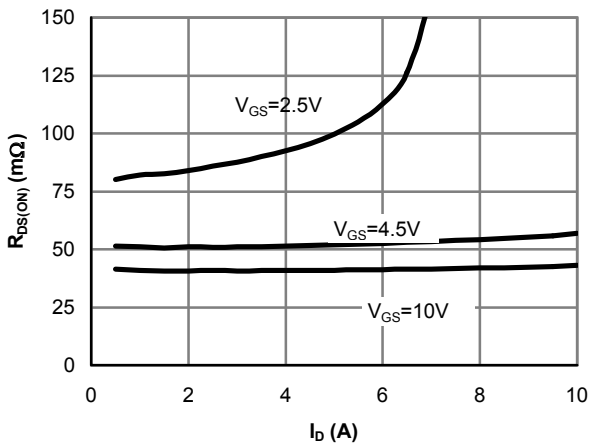

Figure 3: On-Resistance vs. Drain Current and Gate Voltage

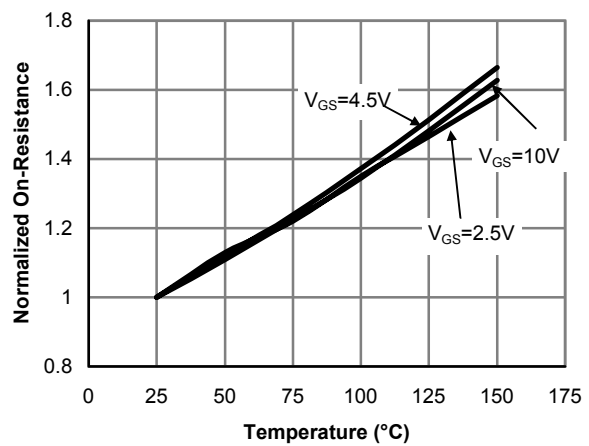

Figure 4: On-Resistance vs. Junction Temperature

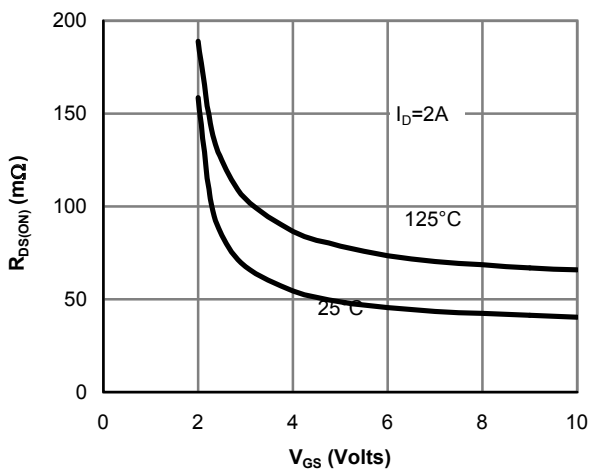

Figure 5: On-Resistance vs. Gate-Source Voltage

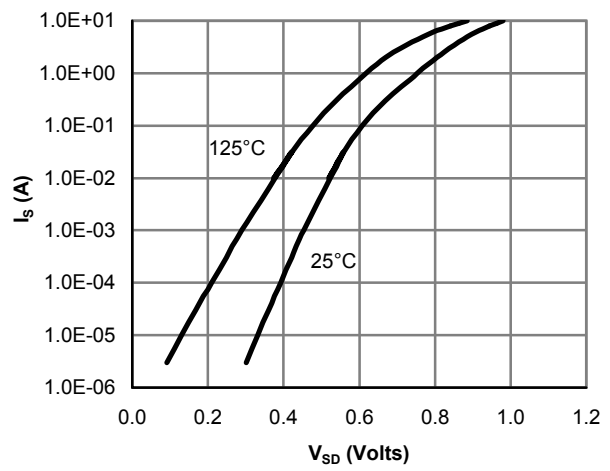

Figure 6: Body-Diode Characteristics

■ Typical Characteristics

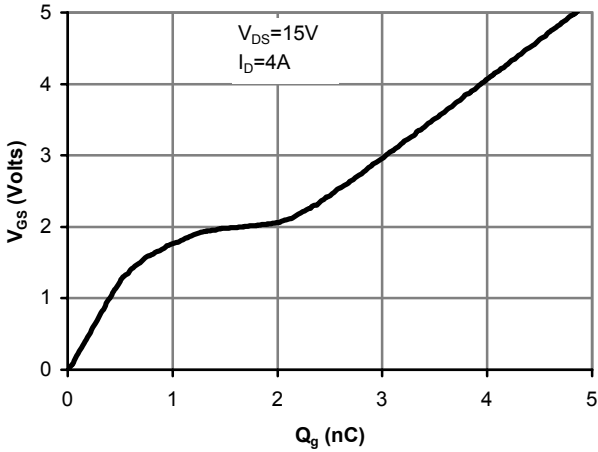

Figure 7: Gate-Charge Characteristics

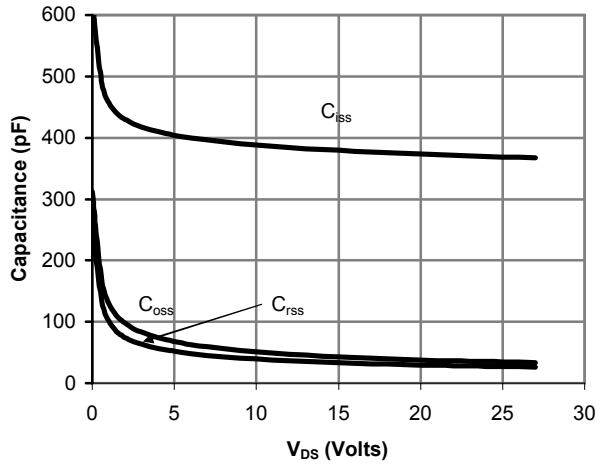

Figure 8: Capacitance Characteristics

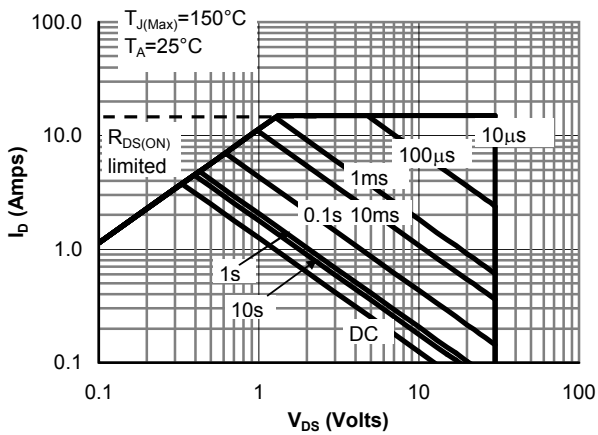

Figure 9: Maximum Forward Biased Safe Operating Area (Note E)

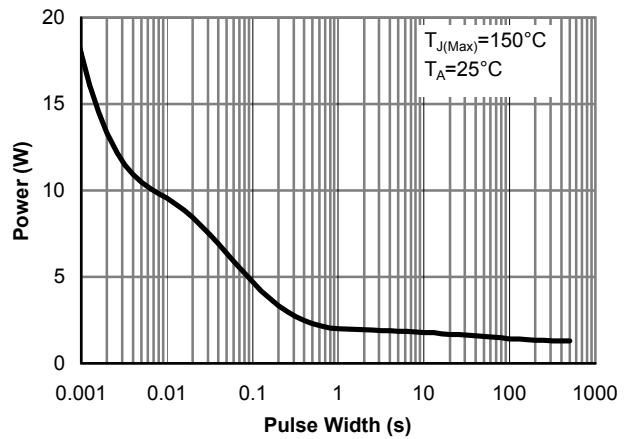

Figure 10: Single Pulse Power Rating Junction-to-Ambient (Note E)

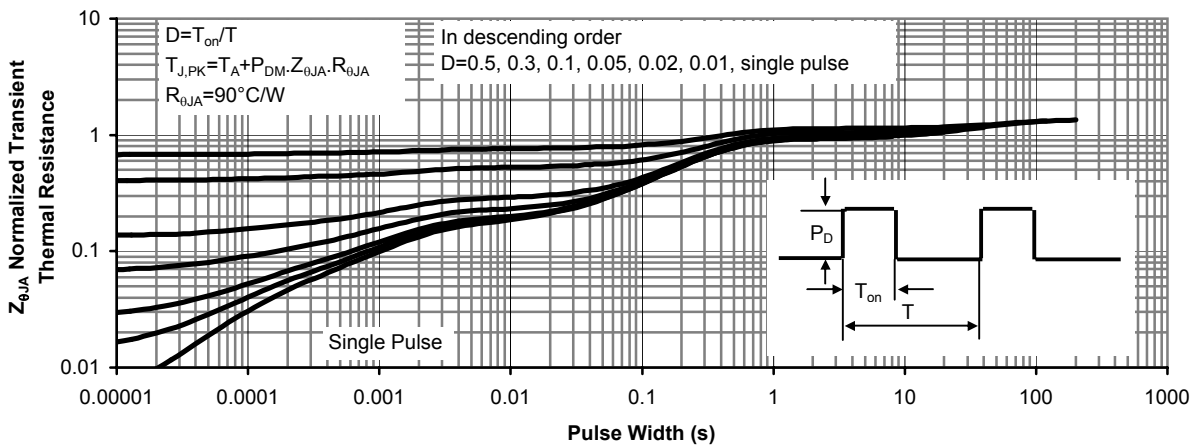
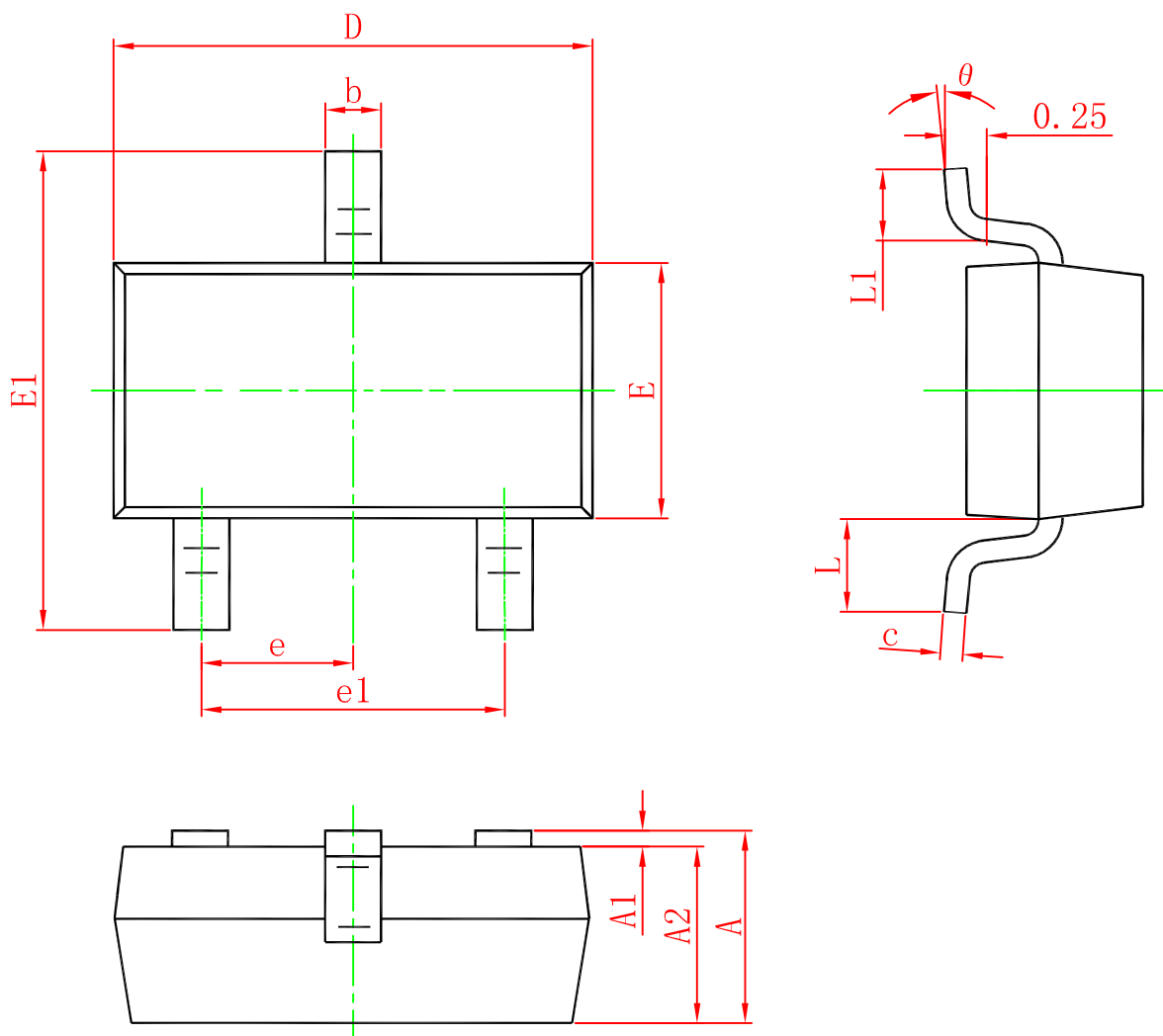

Figure 11: Normalized Maximum Transient Thermal Impedance

SOT-23 PACKAGE OUTLINE DIMENSIONS



Symbol	Dimensions In Millimeters		Dimensions In Inches	
	Min.	Max.	Min.	Max.
A	0.900	1.150	0.035	0.045
A1	0.000	0.100	0.000	0.004
A2	0.900	1.050	0.035	0.041
b	0.300	0.500	0.012	0.020
c	0.080	0.150	0.003	0.006
D	2.800	3.000	0.110	0.118
E	1.200	1.400	0.047	0.055
E1	2.250	2.550	0.089	0.100
e	0.950 TYP.		0.037 TYP.	
e1	1.800	2.000	0.071	0.079
L	0.550 REF.		0.022 REF.	
L1	0.300	0.500	0.012	0.020
θ	0°	8°	0°	8°