

iW1700

Zero Power No-Load Off-Line Digital PWM Controller

1.0 Features

- Zero power consumption at no-load with lowest system cost (< 5 mW at 230 V_{ac} with typical application circuit)
- Intelligent low power management achieves ultra-low operating current at no-load
- Adaptive load transient detection and fast response
- Very tight constant voltage and constant current regulation over entire operating range
- Primary-side feedback eliminates opto-isolators and simplifies design
- **EZ-EMI**® design enhances manufacturability
- Intrinsically low common mode noise
- Optimized 72 kHz maximum PWM switching frequency achieves best size and efficiency
- Active start-up scheme enables fastest possible start-up
- Adaptive multi-mode PWM/PFM control improves efficiency
- Quasi-resonant operation for highest overall efficiency
- Direct drive of low-cost BJT switch
- No external compensation components required
- Complies with EPA 2.0 energy-efficiency specifications with ample margin
- Built-in soft start
- Built-in short circuit protection and output overvoltage protection
- Built-in current sense resistor short circuit protection
- No audible noise over entire operating range

2.0 Description

The iW1700 is a high performance AC/DC power supply controller which uses digital control technology to build peak current mode PWM flyback power supplies. The device together with an external active device (depletion mode NFET or NPN BJT) provides a fast start-up meanwhile achieving ultra-low no-load power consumption. The device directly drives a power BJT and operates in quasi-resonant mode to provide high efficiency along with a number of key built-in protection features while minimizing the external component count, simplifying EMI design and lowering the total bill of material cost. The iW1700 removes the need for secondary feedback circuitry while achieving excellent line and load regulation. It also eliminates the need for loop compensation components while maintaining stability over all operating conditions. Pulse-by-pulse waveform analysis allows for a loop response that is much faster than traditional solutions, resulting in improved dynamic load response, for both one-time and repetitive load transient. The built-in power limit function enables optimized transformer design in universal off-line applications and allows for a wide input voltage range.

iWatt's innovative proprietary technology ensures that power supplies built with the iW1700 can achieve both highest average efficiency and zero no-load power consumption, and have fast load transient response in a compact form factor. The active start-up scheme enables shortest possible start-up time without sacrificing no-load power loss.

3.0 Applications

- Compact AC/DC adapter/chargers for cell phones, PDAs, digital still cameras
- Linear AC/DC replacement

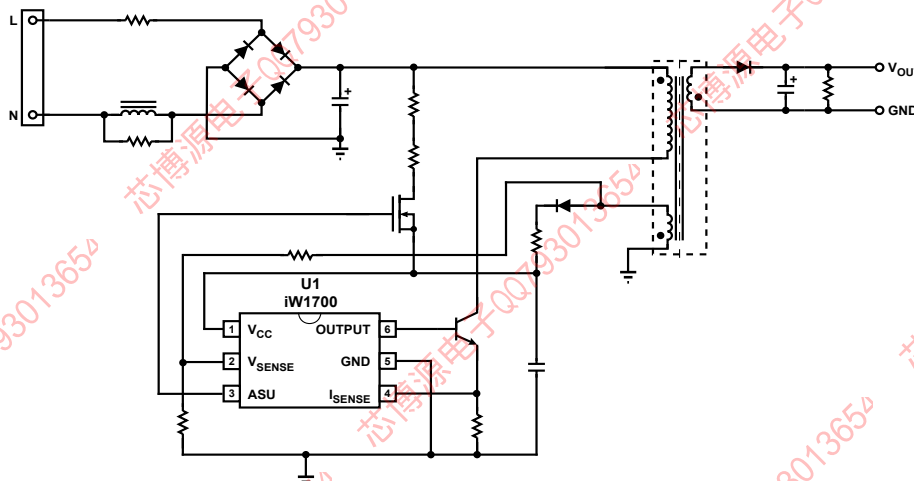

Figure 3.1: iW1700 Typical Application Circuit

(Achieving < 5 mW No-load Power Consumption. Using Depletion Mode NFET as Active Start-up Device)

iW1700

Zero Power No-Load Off-Line Digital PWM Controller

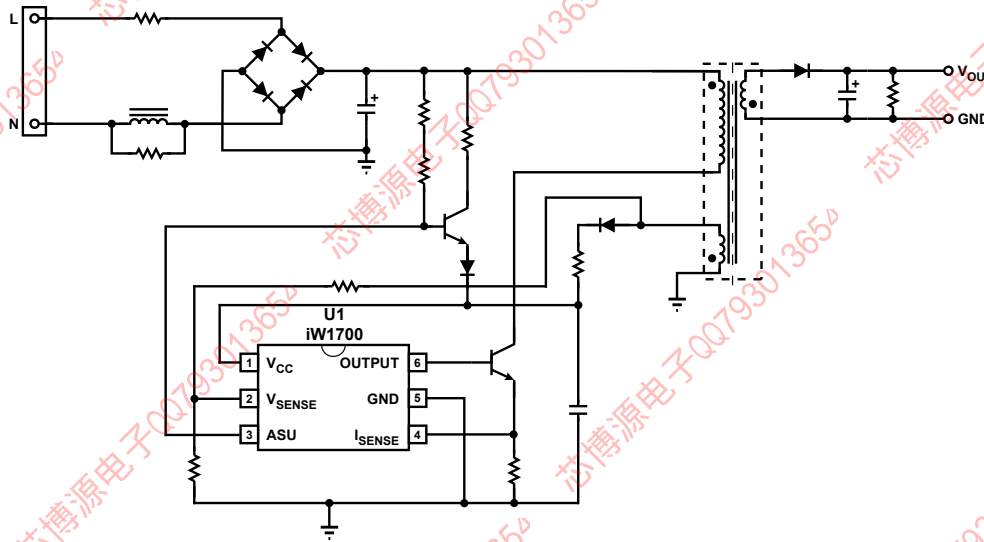

Figure 3.2: iW1700 Typical Application Circuit
(Alternative Circuit Using NPN BJT as the Active Start-up Device)

4.0 Pinout Description

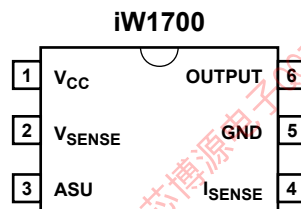

Figure 4.1: 6 Lead SOT-23 Package

Pin #	Name	Type	Pin Description
1	V _{CC}	Power Input	Power supply for control logic.
2	V _{SENSE}	Analog Input	Auxiliary voltage sense (used for primary regulation).
3	ASU	Output	Control signal for active start-up device (BJT or Depletion NFET).
4	I _{SENSE}	Analog Input	Primary current sense. Used for cycle-by-cycle peak current control and limit.
5	GND	Ground	Ground.
6	OUTPUT	Output	Base drive for BJT.

iW1700

Zero Power No-Load Off-Line Digital PWM Controller



5.0 Absolute Maximum Ratings

Absolute maximum ratings are the parameter values or ranges which can cause permanent damage if exceeded. For maximum safe operating conditions, refer to Electrical Characteristics in Section 6.0.

Parameter	Symbol	Value	Units
DC supply voltage range (pin 1, $I_{CC} = 20\text{mA max}$)	V_{CC}	-0.3 to 18.0	V
Continuous DC supply current at V_{CC} pin ($V_{CC} = 15\text{V}$)	I_{CC}	20	mA
ASU output (pin 3)		-0.3 to 18.0	V
Output (pin 6)		-0.3 to 4.0	V
V_{SENSE} input (pin 2, $I_{Vsense} \leq 10\text{ mA}$)		-0.7 to 4.0	V
I_{SENSE} input (pin 4)		-0.3 to 4.0	V
Maximum junction temperature	$T_{J\text{ MAX}}$	150	°C
Storage temperature	T_{STG}	-65 to 150	°C
Lead temperature during IR reflow for ≤ 15 seconds	T_{LEAD}	260	°C
Thermal resistance junction-to-ambient	θ_{JA}	190	°C/W
ESD rating per JEDEC JESD22-A114		2,000	V
Latch-up test per JEDEC 78		± 100	mA

6.0 Electrical Characteristics

$V_{CC} = 12\text{V}$, $-40^\circ\text{C} \leq T_A \leq +85^\circ\text{C}$, unless otherwise specified.

Parameter	Symbol	Test Conditions	Min	Typ	Max	Unit
V_{SENSE} SECTION (Pin 2)						
Input leakage current	I_{BVS}	$V_{SENSE} = 2\text{V}$			1	μA
Nominal voltage threshold	$V_{SENSE(NOM)}$	$T_A = 25^\circ\text{C}$, negative edge	1.518	1.533	1.548	V
Output OVP threshold -00 (Note 1)	$V_{SENSE(MAX)}$	$T_A = 25^\circ\text{C}$, negative edge		1.834		V
Output OVP threshold -01 (Note 1)	$V_{SENSE(MAX)}$	$T_A = 25^\circ\text{C}$, negative edge Load = 100 %		1.926		V
Output OVP threshold -03 (Note 1)	$V_{SENSE(MAX)}$	$T_A = 25^\circ\text{C}$, negative edge Load = 100 %		1.972		V
Output OVP threshold -05 (Note 1)	$V_{SENSE(MAX)}$	$T_A = 25^\circ\text{C}$, negative edge Load = 100 %		1.880		V

iW1700

Zero Power No-Load Off-Line Digital PWM Controller



6.0 Electrical Characteristics

$V_{CC} = 12\text{ V}$, $-40^{\circ}\text{C} \leq T_A \leq +85^{\circ}\text{C}$, unless otherwise specified.

Parameter	Symbol	Test Conditions	Min	Typ	Max	Unit
I_{SENSE} SECTION (Pin 4)						
Overcurrent threshold	V_{OCP}		1.11	1.15	1.19	V
I _{SENSE} regulation upper limit (Note 1)	$V_{IPK(HIGH)}$			1.0		V
I _{SENSE} regulation lower limit (Note 1)	$V_{IPK(LOW)}$			0.23		V
Input leakage current	I_{LK}	$I_{SENSE} = 1.0\text{ V}$			1	μA
OUTPUT SECTION (Pin 6)						
Output low level ON-resistance	$R_{DS(ON)LO}$	$I_{SINK} = 5\text{ mA}$		1	3	Ω
Switching frequency (Note 2)	f_{SW}	> 50% load		72		kHz
V_{CC} SECTION (Pin 1)						
Maximum operating voltage (Note 1)	$V_{CC(MAX)}$				16	V
Start-up threshold	$V_{CC(ST)}$	V_{CC} rising	10.0	11.0	12.0	V
Undervoltage lockout threshold	$V_{CC(UVL)}$	V_{CC} falling	3.8	4.0	4.2	V
Start-up current	$I_{IN(ST)}$	$V_{CC} = 10\text{ V}$	1.0	1.7	3.0	μA
Quiescent current	I_{CCQ}	No I_B current		2.7	4.0	mA
Zener breakdown voltage	V_{ZB}	Zener current = 5 mA $T_A = 25^{\circ}\text{C}$	18.5	19.5	20.5	V
ASU SECTION (Pin 3)						
Maximum operating voltage (Note 1)	$V_{ASU(MAX)}$				16	V
Resistance between V_{CC} and ASU	$R_{V_{CC_ASU}}$			830		k Ω

Notes:

Note 1. These parameters are not 100% tested, guaranteed by design and characterization.

Note 2. Operating frequency varies based on the load conditions, see Section 9.6 for more details.

iW1700

Zero Power No-Load Off-Line Digital PWM Controller

7.0 Typical Performance Characteristics

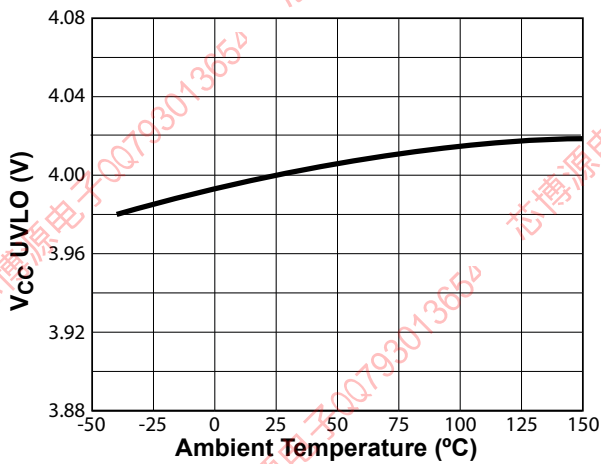

Figure 7.1 : V_{CC} UVLO vs. Temperature

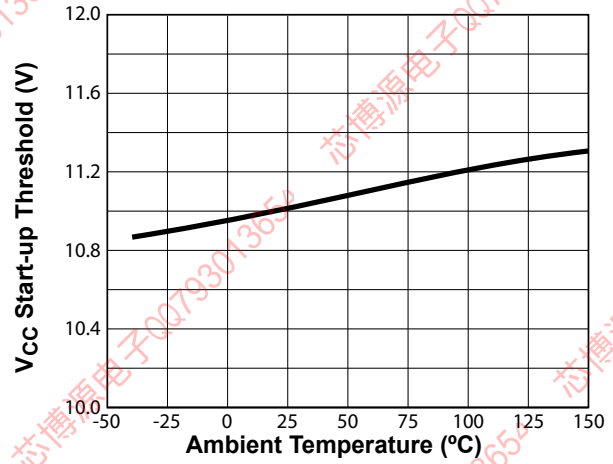

Figure 7.2 : Start-Up Threshold vs. Temperature

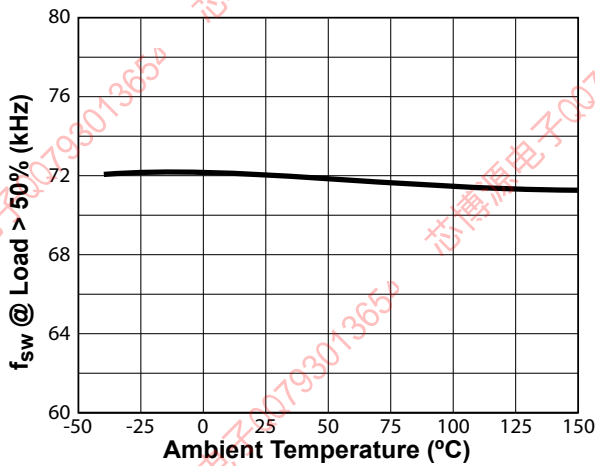

Figure 7.3 : Switching Frequency vs. Temperature¹

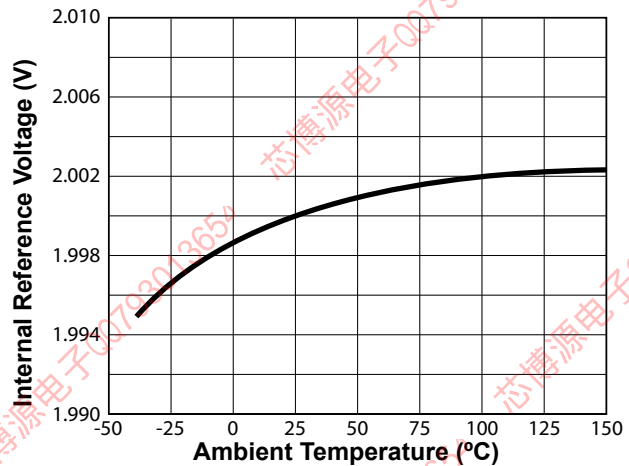

Figure 7.4 : Internal Reference vs. Temperature

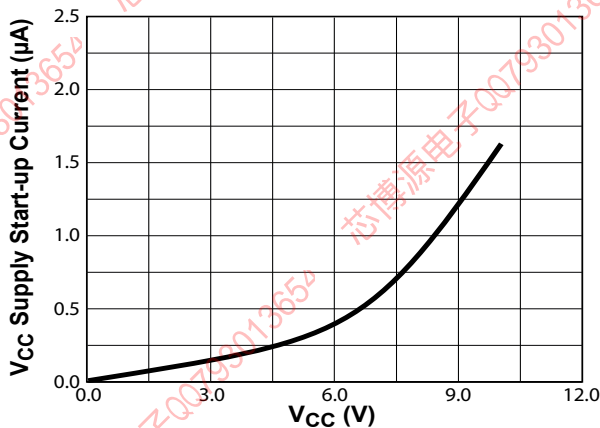

Figure 7.5 : V_{CC} vs. V_{CC} Supply Start-up Current

Notes:

Note 1. Operating frequency varies based on the load conditions, see Section 9.6 for more details.

9.1 Pin Detail

Pin 1 – V_{CC}

Power supply for the controller during normal operation. The controller will start up when V_{CC} reaches 11.0 V (typical) and will shut-down when the V_{CC} voltage is 4.0 V (typical). A decoupling capacitor of 0.1 μF or so should be connected between the V_{CC} pin and GND.

Pin 2 – V_{SENSE}

Sense signal input from auxiliary winding. This provides the secondary voltage feedback used for output regulation.

Pin 3 – ASU

Control signal for active startup device. This signal is pulled low after start-up is finished to cut off the active device.

Pin 4 – I_{SENSE}

Primary current sense. Used for cycle-by-cycle peak current control and limit.

Pin 5 – GND

Ground.

Pin 6 – OUTPUT

Base drive for the external power BJT switch.

9.2 Active Start-up and Soft-start

Refer to Figure 3.1 and Figure 3.2 for active start-up circuits using external depletion NFET and BJT respectively. Prior to start-up, the depletion NFET or the BJT is turned on, allowing the start-up current to charge the V_{CC} bypass capacitor. When the V_{CC} bypass capacitor is charged to a voltage higher than the start-up threshold $V_{CC(ST)}$, the ENABLE signal becomes active and the iW1700 commences soft start function. During this start-up process an adaptive soft-start control algorithm is applied, where the initial output pulses will be small and gradually get larger until the full pulse width is achieved. The peak current is limited cycle by cycle by the I_{PEAK} comparator. If at any time the V_{CC} voltage drops below undervoltage lockout (UVLO) threshold $V_{CC(UVL)}$ then the iW1700 goes to shutdown. At this time ENABLE signal becomes low and the V_{CC} capacitor begins to charge up again towards the start-up threshold to initiate a new soft-start process.

While the ENABLE signal initiates the soft-start process, it also pulls down the ASU pin voltage at the same time, which turns off the depletion NFET or the BJT, thus minimizing the no-load standby power consumption. For the active start-up scheme in Figure 3.2, the start-up resistors connected between the base of the BJT and DC input still conduct current after start-up is finished. They need to be large enough to minimize no-load power consumption. The large start-up resistors require that the BJT have ample gain to obtain a sufficient charge current for a fast start-up.

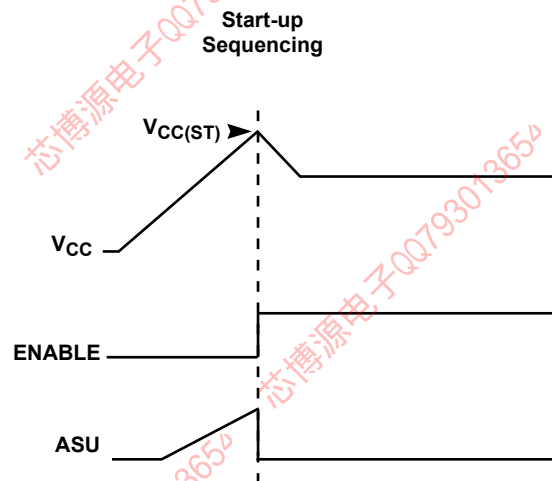

Figure 9.1: Start-up Sequencing Diagram

9.3 Understanding Primary Feedback

Figure 9.2 illustrates a simplified flyback converter. When the switch Q1 conducts during $t_{ON}(t)$, the current $i_g(t)$ is directly drawn from rectified sinusoid $v_g(t)$. The energy $E_g(t)$ is stored in the magnetizing inductance L_M . The rectifying diode D1 is reverse biased and the load current I_o is supplied by the secondary capacitor C_o . When Q1 turns off, D1 conducts and the stored energy $E_g(t)$ is delivered to the output.

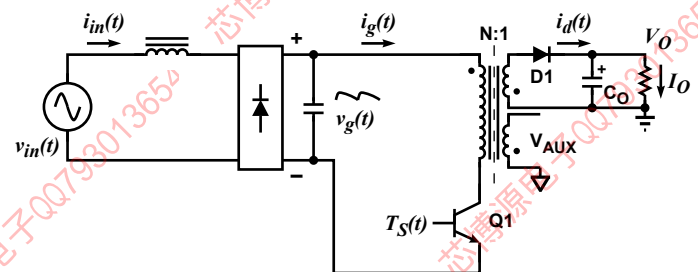

Figure 9.2: Simplified Flyback Converter

In order to tightly regulate the output voltage, the information about the output voltage and load current need

to be accurately sensed. In the DCM flyback converter, this information can be read via the auxiliary winding or the primary magnetizing inductance (L_M). During the Q1 on-time, the load current is supplied from the output filter capacitor C_O . The voltage across L_M is $v_g(t)$, assuming the voltage dropped across Q1 is zero. The current in Q1 ramps up linearly at a rate of:

$$\frac{di_g(t)}{dt} = \frac{v_g(t)}{L_M} \quad (9.1)$$

At the end of on-time, the current has ramped up to:

$$i_{g_peak}(t) = \frac{v_g(t) \times t_{ON}}{L_M} \quad (9.2)$$

This current represents a stored energy of:

$$E_g = \frac{L_M}{2} \times i_{g_peak}^2(t) \quad (9.3)$$

When Q1 turns off at t_o , $i_g(t)$ in L_M forces a reversal of polarities on all windings. Ignoring the commutation-time caused by the leakage inductance L_k at the instant of turn-off t_o , the primary current transfers to the secondary at a peak amplitude of:

$$i_d(t) = \frac{N_P}{N_S} \times i_{g_peak}(t) \quad (9.4)$$

Assuming the secondary winding is master, and the auxiliary winding is slave,

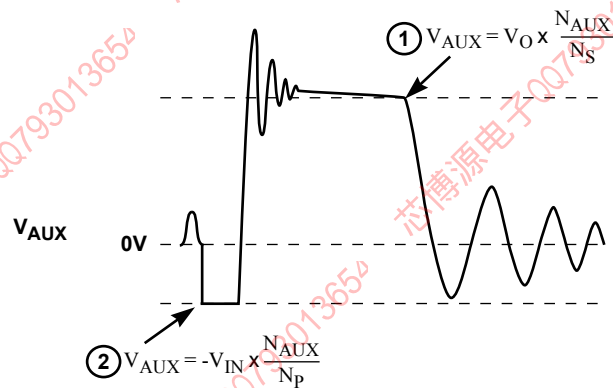

Figure 9.3: Auxiliary Voltage Waveforms

The auxiliary voltage is given by:

$$V_{AUX} = \frac{N_{AUX}}{N_S} (V_O + \Delta V) \quad (9.5)$$

and reflects the output voltage as shown in Figure 9.3.

The voltage at the load differs from the secondary voltage by a diode drop and IR losses. Thus, if the secondary voltage is always read at a constant secondary current, the difference between the output voltage and the secondary voltage will be a fixed ΔV . Furthermore, if the voltage can be read when the secondary current is small, ΔV will also be small. With the iW1700, ΔV can be ignored.

The real-time waveform analyzer in the iW1700 reads this information cycle by cycle. The part then generates a feedback voltage V_{FB} . The V_{FB} signal precisely represents the output voltage under most conditions and is used to regulate the output voltage.

9.4 Constant Voltage Operation

After soft-start has been completed, the digital control block measures the output conditions. It determines output power levels and adjusts the control system according to a light load or heavy load. If this is in the normal range, the device operates in the Constant Voltage (CV) mode, and changes the pulse width (T_{ON}) and off time (T_{OFF}) in order to meet the output voltage regulation requirements.

If no voltage is detected on V_{SENSE} it is assumed that the auxiliary winding of the transformer is either open or shorted and the iW1700 shuts down.

9.5 Constant Current Operation

The constant current (CC) mode is useful in battery charging applications. During this mode of operation the iW1700 will regulate the output current at a constant level regardless of the output voltage, while avoiding continuous conduction mode.

To achieve this regulation the iW1700 senses the load current indirectly through the primary current. The primary current is detected by the I_{SENSE} pin through a resistor from the BJT emitter to ground.

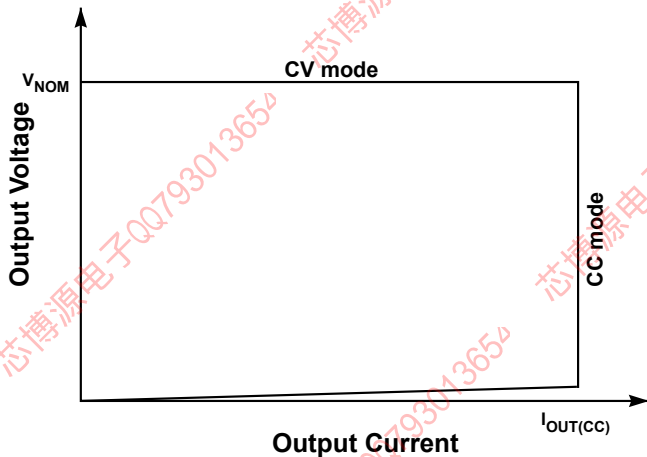

Figure 9.4: Power Envelope

9.6 Multi-Mode PWM/PFM Control and Quasi-Resonant Switching

The iW1700 uses a proprietary adaptive multi-mode PWM / PFM control to dramatically improve the light-load efficiency and thus the overall average efficiency.

During the constant voltage (CV) operation, the iW1700 normally operates in a pulse-width-modulation (PWM) mode during heavy load conditions. In the PWM mode, the switching frequency keeps around constant. As the output load I_{OUT} is reduced, the on-time t_{ON} is decreased, and the controller adaptively transitions to a pulse-frequency-modulation (PFM) mode. During the PFM mode, the BJT is turned on for a set duration under a given instantaneous rectified AC input voltage, but its off time is modulated by the load current. With a decreasing load current, the off time increases and thus the switching frequency decreases.

When the switching frequency approaches to human ear audio band, the iW1700 transitions to a second level of PWM mode, namely Deep PWM mode (DPWM). During the DPWM mode, the switching frequency keeps around 25 kHz in order to avoid audible noise. As the load current is further reduced, the iW1700 transitions to a second level of PFM mode, namely Deep PFM mode (DPFM), which can reduce the switching frequency to a very low level. Although the switching frequency drops across the audible frequency range during the DPFM mode, the output current in the power converter has reduced to an insignificant level in the DPWM mode before transitioning to the DPFM mode. Therefore, the power converter practically produces no audible noise, while achieving high efficiency across varying load conditions.

The iW1700 also incorporates a unique proprietary quasi-resonant switching scheme that achieves valley-mode turn on for every PWM/PFM switching cycle, during all PFM and PWM modes and in both CV and CC operations. This unique feature greatly reduces the switching loss and dv/dt across the entire operating range of the power supply. Due to the nature of quasi-resonant switching, the actual switching frequency can vary slightly cycle by cycle, providing the additional benefit of reducing EMI. Together these innovative digital control architecture and algorithms enable the iW1700 to achieve highest overall efficiency and lowest EMI, without causing audible noise over entire operating range.

9.7 Zero Power No-Load Operation

At the no-load condition, the iW1700 is operating in the DPFM mode, where the switching frequency can drop as low as 275 Hz and still maintain tight closed-loop control of output voltage. The distinctive DPFM operation allows the use of a relatively large pre-load resistor which helps reduce the no-load power consumption. In the meanwhile, the iW1700 implements an intelligent low-power management technique that achieves ultra-low chip operating current at the no-load, typically less than 400 μA . One important feature of the iW1700 is that it directly drives a low-cost BJT switch. Unlike a power MOSFET, the BJT is a current-driven device that does not require a high driving voltage. As a result, the UVLO threshold of the iW1700 is designed to be as low as 4.0 V (typical). The power supply system design can fully utilize this low UVLO feature to have a low V_{CC} voltage at the no-load operation in order to minimize the no-load power. In addition, the active start-up scheme with depletion NFET eliminates the startup resistor power consumption after the ENABLE signal becomes active. All together these features ensure with the lowest system cost power supplies built with the iW1700 can achieve less than 5 mW no-load power consumption at 230 Vac input and maintain very tight constant voltage and constant current regulation over the entire operating range including the no-load operation.

While achieving ultra-low no-load power consumption, the iW1700 implements innovative proprietary digital control technology to intelligently detect load transient events, and ensure adaptive fast response.

9.8 Variable Frequency Operation Mode

At each of the switching cycles, the falling edge of V_{SENSE} will be checked. If the falling edge of V_{SENSE} is not detected, the off-time will be extended until the falling edge of V_{SENSE} is detected. The maximum allowed transformer reset time is 110 μs . When the transformer reset time reaches 110 μs , the iW1700 shuts off.

9.9 Internal Loop Compensation

The iW1700 incorporates an internal Digital Error Amplifier with no requirement for external loop compensation. For a typical power supply design, the loop stability is guaranteed to provide at least 45 degrees of phase margin and -20 dB of gain margin.

9.10 Voltage Protection Features

The secondary maximum output DC voltage is limited by the iW1700. When the V_{SENSE} signal exceeds the output OVP threshold at point 1 indicated in Figure 9.3 the iW1700 shuts down.

The iW1700 protects against input line undervoltage by setting a maximum T_{ON} time. Since output power is proportional to the squared $V_{IN} T_{ON}$ product, then for a given output power, as V_{IN} decreases the T_{ON} will increase. Thus by knowing when the maximum T_{ON} time occurs the iW1700 detects that the minimum V_{IN} is reached, and shuts down. The maximum t_{ON} limit is set to 13.8 μs . Also, the iW1700 monitors the voltage on the V_{CC} pin and when the voltage on this pin is below UVLO threshold the IC shuts down immediately.

When any of these faults are met the IC remains biased to discharge the V_{CC} supply. Once V_{CC} drops below UVLO threshold, the controller resets itself and then initiates a new soft-start cycle. The controller continues attempting start-up until the fault condition is removed.

9.11 PCL, OCP and SRS Protection

Peak-current limit (PCL), over-current protection (OCP) and sense-resistor short protection (SRSP) are features built-in to the iW1700. With the I_{SENSE} pin the iW1700 is able to monitor the peak primary current. This allows for cycle by cycle peak current control and limit. When the primary peak current multiplied by the I_{SENSE} resistor is greater than 1.15 V, over current (OCP) is detected and the IC will immediately turn off the base driver until the next cycle. The output driver will send out a switching pulse in the next cycle, and the switching pulse will continue if the OCP threshold is not reached; or, the switching pulse will turn off again if the OCP threshold is reached. If the OCP occurs for several consecutive switching cycles, the iW1700 shuts down.

If the I_{SENSE} resistor is shorted there is a potential danger of the over current condition not being detected. Thus, the IC is designed to detect this sense-resistor-short fault after startup and shut down immediately. The V_{CC} will be discharged since the IC remains biased. Once V_{CC} drops

below the UVLO threshold, the controller resets itself and then initiates a new soft-start cycle. The controller continues attempting to startup, but does not fully startup until the fault condition is removed.

9.12 Dynamic Base Current Control

One important feature of the iW1700 is that it directly drives a BJT switching device with dynamic base current control to optimize performance. The BJT base current ranges from 10 mA to 31 mA, and is dynamically controlled according to the power supply load change. The higher the output power, the higher the base current. Specifically, the base current is related to V_{IPK} , as shown in Figure 9.5.

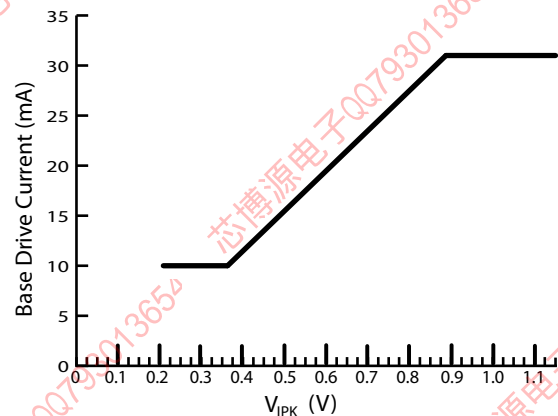

Figure 9.5: Base Drive Current vs. V_{IPK}

9.13 Cable Drop Compensation

The iW1700 incorporates an innovative method to compensate for any IR drop in the secondary circuitry including cable and cable connector. A 2.5 W adapter with 5 V DC output has 3% deviation at 0.5 A load current due to the drop across a 24 AWG, 1.8 meter DC cable without cable compensation. The iW1700 compensates for this voltage drop by providing a voltage offset to the feedback signal based on the amount of load current detected.

The “Cable Comp” specified in the Table in Section 11.0 refers to the voltage increment at PCB end from no-load to full-load conditions in the CV mode, with the assumption that the secondary diode voltage drop can be ignored at the point when the secondary voltage is sensed. Also, the “Cable Comp” is specified based on the nominal output voltage of 5 V. For different output voltage, the actual voltage increment needs to be scaled accordingly. To calculate the amount of cable compensation needed, take the resistance of the cable and connector and multiply by the maximum output current.

iW1700

Zero Power No-Load Off-Line Digital PWM Controller



10.0 Physical Dimensions

6-Lead SOT Package

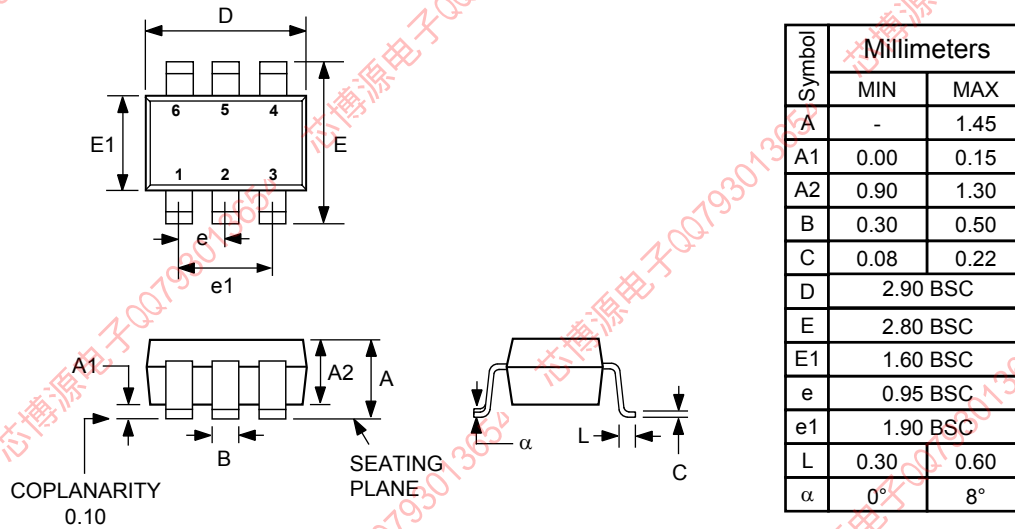

Figure 10.1: Physical dimensions, 6-lead SOT-23 package

Compliant to JEDEC Standard MO-178AB

Controlling dimensions are in millimeters

This package is RoHS compliant and Halide free.

Soldering Temperature Resistance:

[a] Package is IPC/JEDEC Std 020D Moisture Sensitivity Level 1

[b] Package exceeds JEDEC Std No. 22-A111 for Solder Immersion Resistance; packages can withstand 10 s immersion < 270°C

Dimension D does not include mold flash, protrusions or gate burrs. Mold flash, protrusions or gate burrs shall not exceed 0.25 mm per side.

The package top may be smaller than the package bottom. Dimensions D and E1 are determined at the outermost extremes of the plastic body exclusive of mold flash, tie bar burrs and interlead flash, but including any mismatch between top and bottom of the plastic body.

11.0 Ordering Information

Part Number	Options	Package	Description
iW1700-00	Cable Comp = 0 mV	SOT-23	Tape & Reel ¹
iW1700-01	Cable Comp = 300 mV	SOT-23	Tape & Reel ¹
iW1700-03	Cable Comp = 450 mV	SOT-23	Tape & Reel ¹
iW1700-05	Cable Comp = 150 mV	SOT-23	Tape & Reel ¹

Note 1: Tape & Reel packing quantity is 3,000 per reel. Minimum ordering quantity is 3,000.

iW1700

Zero Power No-Load Off-Line Digital PWM Controller



About iWatt

iWatt Inc. is a fabless semiconductor company that develops intelligent power management ICs for computer, communication, and consumer markets. The company's patented *pulseTrain*™ technology, the industry's first truly digital approach to power system regulation, is revolutionizing power supply design.

Trademark Information

© 2012 iWatt, Inc. All rights reserved. iWatt, *EZ-EMI* and *pulseTrain* are trademarks of iWatt, Inc. All other trademarks and registered trademarks are the property of their respective companies.

Contact Information

Web: <https://www.iwatt.com>

E-mail: info@iwatt.com

Phone: 408-374-4200

Fax: 408-341-0455

iWatt Inc.

675 Campbell Technology Parkway, Suite 150
Campbell, CA 95008

Disclaimer

iWatt reserves the right to make changes to its products and to discontinue products without notice. The applications information, schematic diagrams, and other reference information included herein is provided as a design aid only and are therefore provided as-is. iWatt makes no warranties with respect to this information and disclaims any implied warranties of merchantability or non-infringement of third-party intellectual property rights.

iWatt cannot assume responsibility for use of any circuitry other than circuitry entirely embodied in an iWatt product. No circuit patent licenses are implied.

Certain applications using semiconductor products may involve potential risks of death, personal injury, or severe property or environmental damage ("Critical Applications").

IWATT SEMICONDUCTOR PRODUCTS ARE NOT DESIGNED, INTENDED, AUTHORIZED, OR WARRANTED TO BE SUITABLE FOR USE IN LIFE-SUPPORT APPLICATIONS, DEVICES OR SYSTEMS, OR OTHER CRITICAL APPLICATIONS.

Inclusion of iWatt products in critical applications is understood to be fully at the risk of the customer. Questions concerning potential risk applications should be directed to iWatt, Inc.

iWatt semiconductors are typically used in power supplies in which high voltages are present during operation. High-voltage safety precautions should be observed in design and operation to minimize the chance of injury.