



SOT-23 Plastic-Encapsulate Diodes

BAW56/BAV70BAV99 SWITCHING DIODE

FEATURES

- Fast Switching Speed
- For General Purpose Switching Applications
- High Conductance

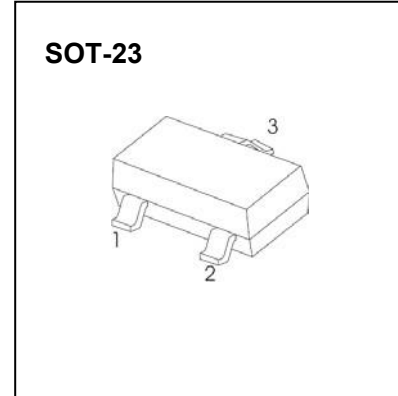

BAW56	BAV70	BAV99
MARKING:A1	MARKING:A4	MARKING:A7

Solid dot = Green molding compound device,
if none, the normal device

Maximum Ratings @Ta=25°C

Parameter	Symbol	Limit	Unit
Reverse Voltage	V_R	70	V
Forward Current	I_F	200	mA
Non-Repetitive Peak Forward Surge Current @t=8.3ms	I_{FSM}	2.0	A
Power Dissipation	P_D	225	mW
Thermal Resistance Junction to Ambient	$R_{\theta JA}$	556	°C/W
Junction Temperature	T_J	150	°C
Storage Temperature range	T_{STG}	-55~+150	°C

Electrical Characteristics @Ta=25°C

Parameter	Symbol	Min	Typ	Max	Unit	Conditions
Reverse breakdown voltage	V_R	70			V	$I_R=100\mu A$
Forward voltage	V_{F1}			0.715	V	$I_F=1mA$
	V_{F2}			0.855	V	$I_F=10mA$
	V_{F3}			1	V	$I_F=50mA$
	V_{F4}			1.25	V	$I_F=150mA$
Reverse current	I_R			2.5	μA	$V_R=70V$
Capacitance between terminals	C_T			1.5	pF	$V_R=0, f=1MHz$
Reverse recovery time	t_{rr}			6	ns	$I_F = I_R = 10mA,$ $I_{rr} = 0.1 \times I_R, R_L = 100\Omega$



Forward Characteristics

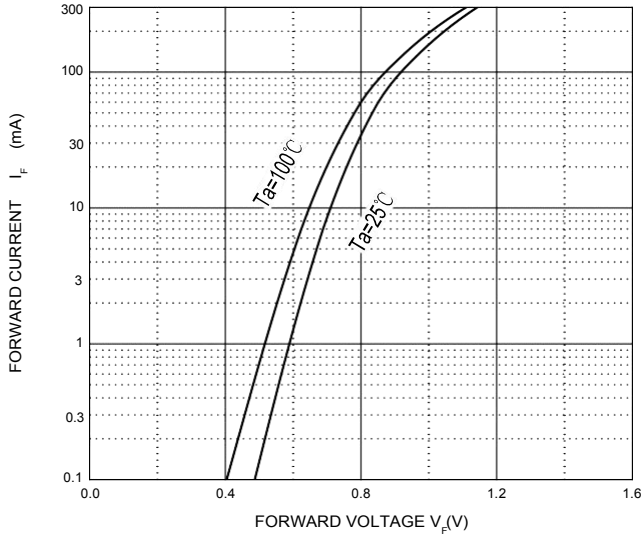

Reverse Characteristics

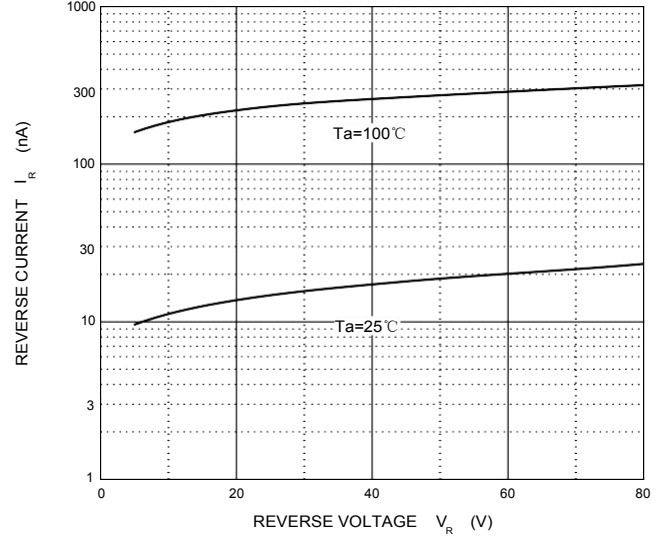

Capacitance Characteristics

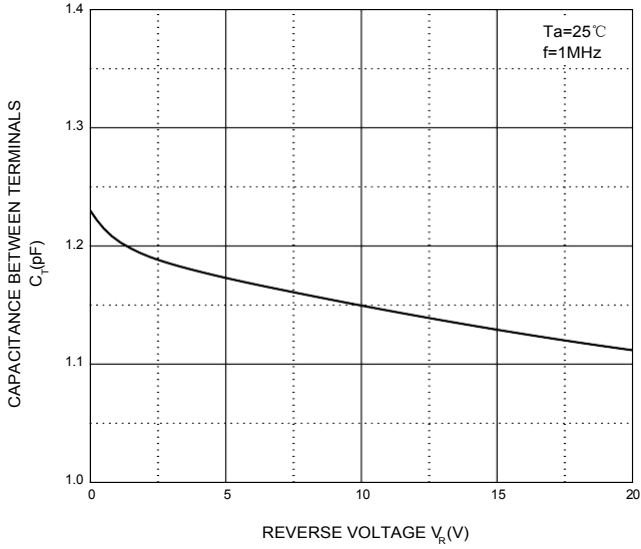

Power Derating Curve

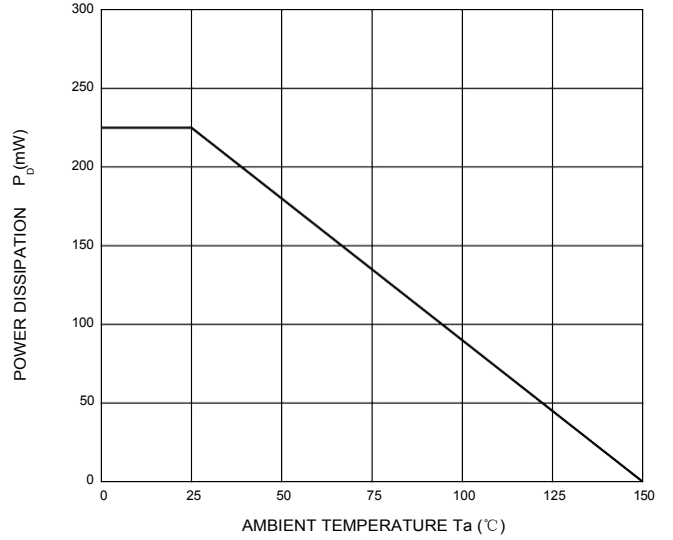



SOT-23 Package Outline Dimensions

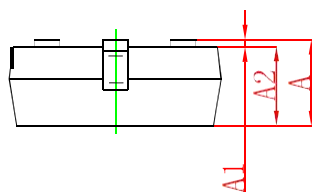
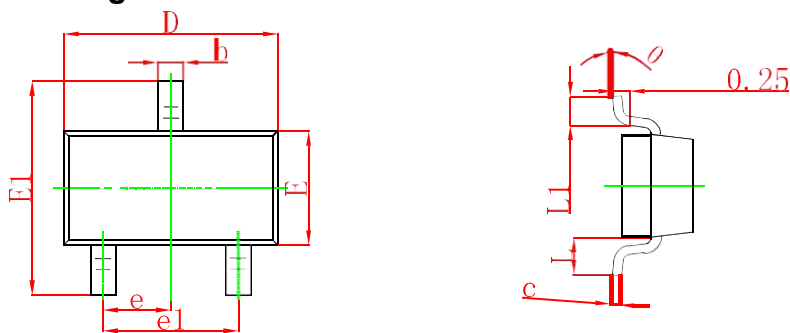

Symbol	Dimensions In Millimeters		Dimensions In Inches	
	Min	Max	Min	Max
A	0.900	1.150	0.035	0.045
A1	0.000	0.100	0.000	0.004
A2	0.900	1.050	0.035	0.041
b	0.300	0.500	0.012	0.020
c	0.080	0.150	0.003	0.006
D	2.800	3.000	0.110	0.118
E	1.200	1.400	0.047	0.055
E1	2.250	2.550	0.089	0.100
e	0.950 TYP		0.037 TYP	
e1	1.800	2.000	0.071	0.079
L	0.550 REF		0.022 REF	
L1	0.300	0.500	0.012	0.020
θ	0°	8°	0°	8°

SOT-23 Suggested Pad Layout

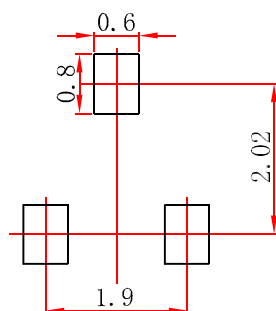

- Note:
1. Controlling dimension: in millimeters.
 2. General tolerance: $\pm 0.05\text{mm}$.
 3. The pad layout is for reference purposes only.