

Design Based on Micro Strip Line Technology

- Isolation characteristics of 65 dB or better at 900 MHz
- Effective insertion loss characteristics of 0.2 dB or better at 900 MHz (half the loss of earlier models)
- Fully-scaled construction
- Improved shock-resistance
- Applications include cable TV, cellular communication, HDTV, fax machine, satellite communications, pay TV, VCRs, and test and measurement equipment

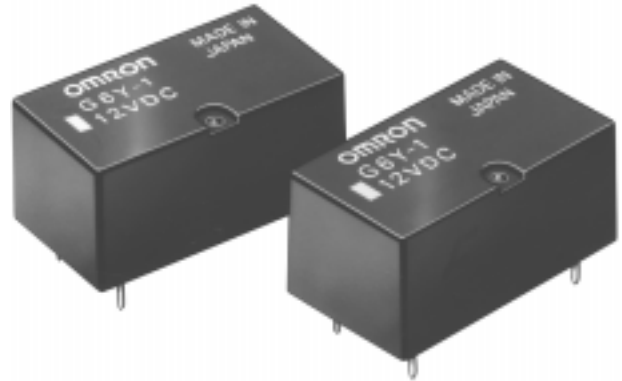

Ordering Information

To order: Select the part number and add the desired coil voltage rating (e.g. G6Y-1-DC12).

Type	Contact form	Construction	Part number
Standard	SPDT	Fully-sealed	G6Y-1

Specifications

■ COIL DATA

Rated voltage (VDC)	Rated current (mA)	Coil resistance (Ω)	Must operate voltage	Must dropout voltage	Maximum voltage	Power consumption (mW)
			% of rated voltage			
5	40.0	125	75% max.	10% min.	150 at 23°C (73°F) 130 at 70°C (158°F)	Approx. 200
6	33.3	180				
9	22.2	405				
12	16.7	720				
24	8.3	2,880				

Note: The rated current and coil resistance are measured at a coil temperature of 23°C with a tolerance of ±10%.

The operating characteristics are measured at a coil temperature of 23°C.

The "Max. allowed voltage" is the maximum voltage that can be applied to the relay coil. It is not the maximum voltage that can be applied continuously.

■ CONTACT DATA

Load	Resistive load (p.f. = 1)
Rated load	0.01 A at 30 VAC 0.01 A at 30 VDC 900 MHz, 1 W (See Note.)
Contact material	Au clad Cu alloy
Max. carry current	0.5 A
Max. operating voltage	30 VAC 30 VDC
Max. operating current	0.5 A
Max. switching capacity	AC10 VA DC10 W
Min. permissible load	10 mA at 10 mVDC

Note: This value is for a load with VSWR \leq 1.2.

■ HIGH-FREQUENCY CHARACTERISTICS

Item	250 MHz	900 MHz	2.5 GHz
Isolation	80 dB min.	65 dB min.	30 dB min.
Insertion loss	0.5 dB max.	0.5 dB max.	consult factory
VSWR	1.5 max.	1.5 max.	
Max. carry power	10 W		
Max. operating power	10 W (See Note 2.)		

Note: 1. The impedance of the measuring system is 50 Ω . The table above shows preliminary values.

2. This value is for a load with VSWR \leq 1.2.

■ CHARACTERISTICS

Contact resistance (See Note 2.)	100 m Ω max.	
Operating time	10 ms max. (approx. 5 ms)	
Release time	5 ms max. (approx. 1 ms)	
Insulation resistance	100 M Ω min. (at 500 VDC)	
Dielectric strength	1,000 VAC, 50/60 Hz for 1 min between coil and contacts	
	500 VAC, 50/60 Hz for 1 min between contacts of same polarity	
	500 VAC, 50/60 Hz for 1 min between coil and ground and between contacts and ground	
Vibration resistance	Destruction: 10 Hz to 55 Hz, 1.5 mm double amplitude Malfunction: 10 Hz to 55 Hz, 1.5 mm double amplitude	
Shock resistance	Destruction: 1,000 m/s ² (approx. 100G) Malfunction: 1,000 m/s ² (approx. 100G)	
Life expectancy	Mechanical: 1,000,000 operations min. (at 1,800 operations/hr.) Electrical: 300,000 operations min. (under rated load at 1,800 operations/hr.)	
Ambient temperature	Operating	-40°C to 70°C (-40°F to 158°F) with no icing
	Storage	-40°C to 70°C (-40°F to 158°F) with no icing
Ambient humidity	Operating	35 to 85%
	Storage	35 to 85%
Weight	Approx. 5 g	

Note: 1. The table above shows preliminary values at room temperature unless otherwise specified.

2. Measurement Conditions: 5 VDC, 100 mA, voltage drop method.

Engineering Data

■ AMBIENT TEMPERATURE VS. MAX. ALLOWED VOLTAGE

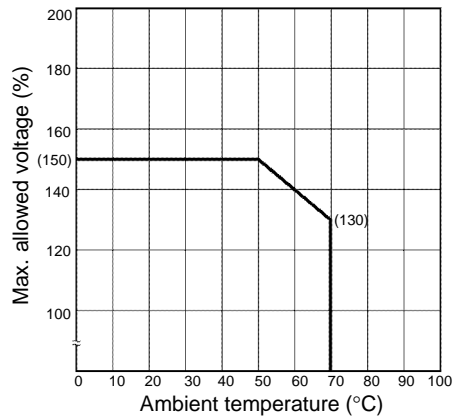

Note: The "Max. allowed voltage" is the maximum voltage that can be applied to the relay coil. It is not the maximum voltage that can be applied continuously.

■ CONTACT RELIABILITY TEST (AMBIENT TEMPERATURE OF 23°C)

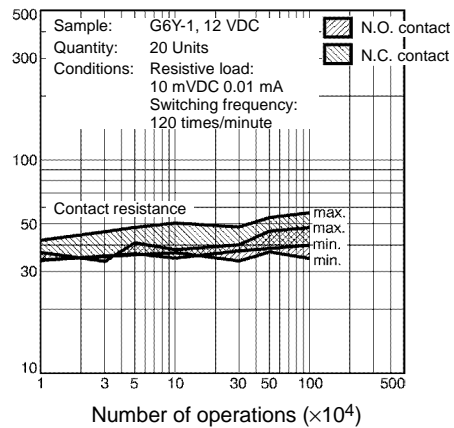

■ RESISTANCE TO SHOCK

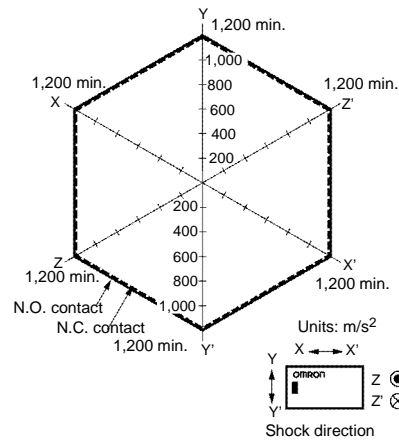

Quantity Tested: 10 Units

Test Method: Shock was applied 3 times in each direction with and without excitation and the level at which the shock caused malfunction was measured.

Rating: 500 m/s² (approx. 50G)

■ HIGH-FREQUENCY CHARACTERISTICS

Measurement Conditions

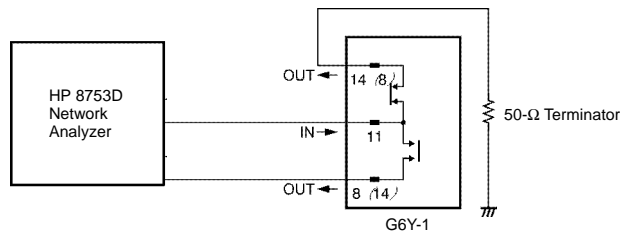

Terminals which were not being measured were terminated with 50 Ω

Note: The high-frequency characteristics data were measured using a dedicated circuit board and actual values will vary depending on the usage conditions. Check the characteristics of the actual equipment being used.

ISOLATION CHARACTERISTICS (AVERAGE VALUES)

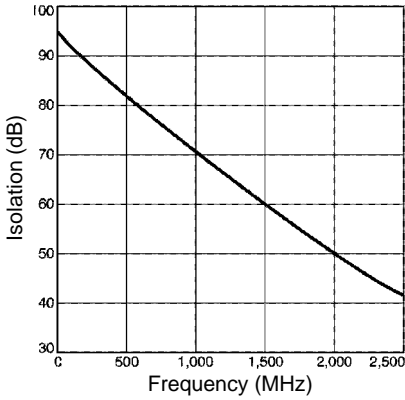

INSERTION LOSS CHARACTERISTICS (AVERAGE VALUES)

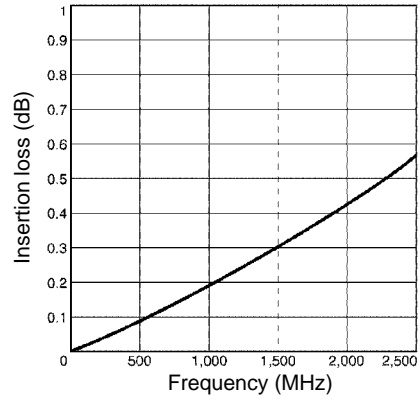

VSWR, RETURN LOSS CHARACTERISTICS (AVERAGE VALUES)

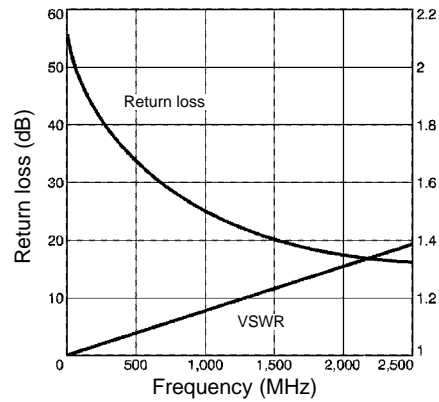

OPERATING RELEASE TIME DISTRIBUTION (AMBIENT TEMPERATURE OF 23°C)

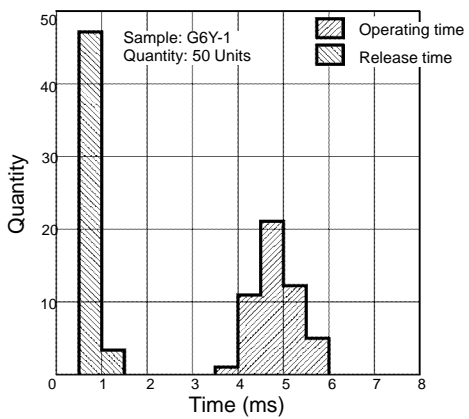

BOUNCE TIME DISTRIBUTION (AMBIENT TEMPERATURE OF 23°C)

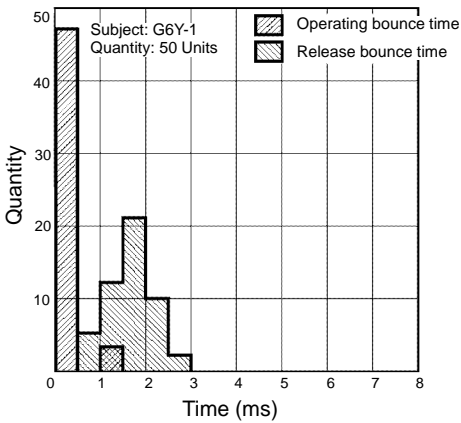

Dimensions

Unit: mm (inch)

■ G6Y-1

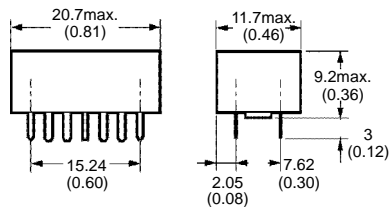

PCB Dimensions (Bottom View)

Tolerances: ± 0.1 mm.

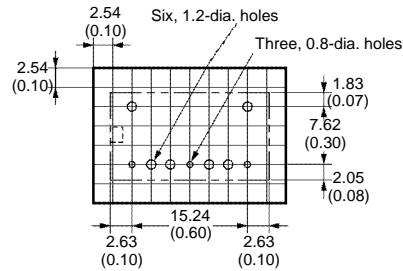

(Holes for the coil terminals may also be 1.0.)

Terminal Arrangement/ Internal Connections (Bottom View)

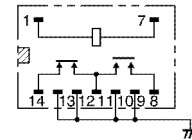

Note: The shaded and unshaded parts indicate the product's directional marks.

Precautions

■ CORRECT USE

Seal integrity during cleaning will last for 1 minute at 70°C.

Micro Strip Line Design

- It is advantageous to use the Micro Strip Line in high-frequency transmission circuits because a low-loss transmission can be achieved with this method. By etching the dielectric base which has copper foil attached to both sides, the Micro Strip Line will have a concentrated electric field between the lines and ground, as shown in the following diagram.

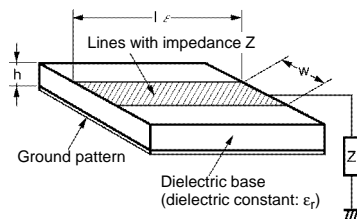

- The characteristic impedance of the lines Z_0 is determined by the kind of base (dielectric constant), the base's thickness, and the width of the lines, as expressed in the following equation.

$$Z_0 = \frac{377}{\sqrt{\epsilon_r} \frac{W}{H} \left\{ 1 + \frac{2H}{\pi W} \left[1 + \ln \frac{\pi W}{H} \right] \right\}}$$

W: Line width

ϵ_r : Effective dielectric constant

H: Dielectric base thickness

The copper foil thickness must be less than H.

- The following graph shows this relationship.

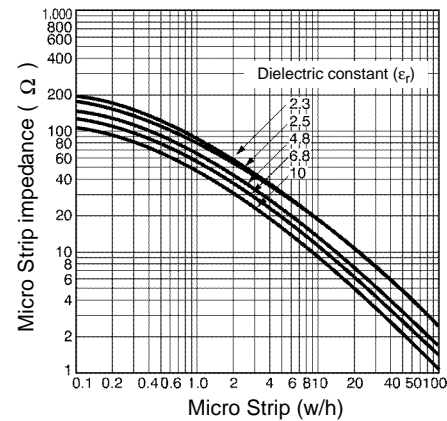

- For example, when creating 50- Ω lines using a glass epoxy base with a thickness of 1.6 mm, the above graph will yield a w/h ratio of 1.7 for a dielectric constant of 4.8. Since the base thickness is 1.6 mm, the width will be $h \times 1.7 \approx 2.7$ mm. The thickness of the copper foil "t" is ignored in this design method, but it must be considered because large errors will occur in extreme cases such as a foil thickness of $t \approx w$. In addition, with the Micro Strip Line design, the lines are too short for the G6Y's intended frequency bandwidths, so we can ignore conductive losses and the line's attenuation constant.
- The spacing of the Strip Lines and ground pattern should be comparable to the width of the Strip Lines.

- Design the pattern with the shortest possible distances. Excessive distances will adversely effect the high-frequency characteristics.
- Spread the ground patterns as widely as possible so that potential differences are unlikely to develop between the ground patterns.
- To avoid potential short-circuits, do not place the pattern's leads near the point where the bottom of the Relay attaches to the board.

Bending the Micro Strip Line

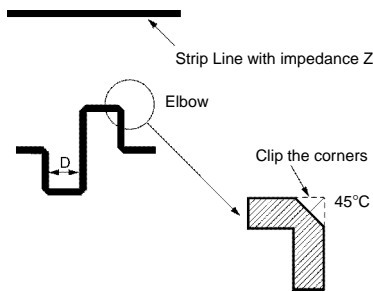

When the lines must curve, an elbow can be used as shown in the diagram. A distance (D) between the lines of approximately twice the line width is sufficient.

EXAMPLES OF MOUNTING DESIGNS

Since this example emphasizes reducing mounting costs, expensive mounting methods, such as through-hole boards, are not shown. If such methods are to be used, the characteristics must be studied carefully, using the actual board configuration.

Using a Double-sided Paper Epoxy Board

When double-sided paper epoxy boards are used, the dielectric constant will be approximately the same as that of glass epoxy boards ($\epsilon_r=4.8$).

The width of the Strip Lines for a board with $t=1.6$ mm is 2.7 mm for 50 Ω and 1.8 mm for 75 Ω . For a board with $t=1.0$ mm the width is 1.7 mm for 50 Ω and 0.8 mm for 75 Ω .

The following diagram shows an example pattern, and the Micro Strip Lines connected to the contact terminals are formed with pattern widths derived from the description above. The width between the Micro Strip Lines and ground patterns are comparable to the Micro Strip Line width.

There are jumpers between the upper and lower patterns at the points marked with Xs in the diagram. Improved characteristics can be obtained with more jumper locations. This method yields isolation characteristics of 65 dB to 75 dB at 500 MHz and 50 dB at 900 MHz.

At this point in the diagram the component side is the entire ground pattern side; but, you must set aside approximately 2.0 mm \times 2.0 mm of the pattern for the contact terminals and coil terminals.

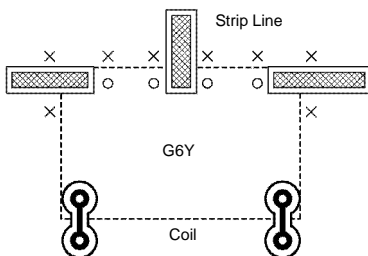

Using a Single-sided Board

When a single-sided board is used, isolation characteristics of only 60 dB to 70 dB at 200 MHz can be obtained. When high frequency bands are to be used with a single-sided board, a metal plate can be placed between the base and Relay and connected to the ground pattern.

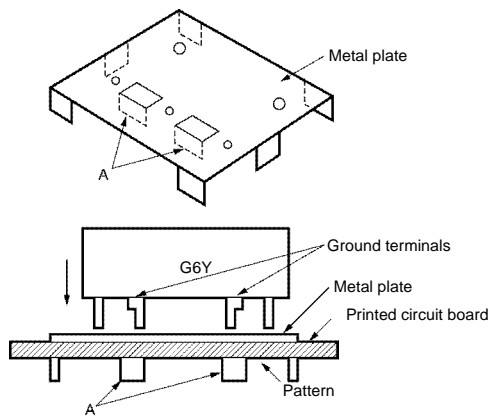

With this method a metal plate is placed between the Relay and base and connected to the pattern, as shown in the above diagram. The important point here is that 3 locations (the G6Y's ground terminal, the metal plate's bent tabs (A), and the ground pattern) are soldered together at the same time. This method combines an inexpensive single-sided board and inexpensive metal plate to yield the same characteristics as a double-sided board. Good characteristics are obtained by grounding the G6Y's ground terminal and metal plate in the same place.

The metal plate must be attached to the base as described here. From this point, the methods used for Strip Line design are the same as for the double-sided board.

Mounting Precautions

Be sure to securely attach the Relay's base surface to the board during installation. The isolation characteristics will be affected if the Relay lifts off the board.

As shown in the enlarged illustration of the cross-section of part A, the G6Y is designed to ensure better high-frequency characteristics if the stand-off part of the G6Y is in contact with the ground pattern of the PCB. For this reason, the ground terminal and stand-off part are electrically connected internally.

Should the through hole electrically connected to the contact terminal come in contact with the stand-off part, the contact will be short-circuited with the ground, which may cause an accident.

As a preventive measure, keep at least a distance of 0.3 mm between the stand-off part and the through hole or land.

For example, if the terminal hole on the PCB is 1 mm in diameter and the length B shown in the illustration is 1.4 mm, a distance of 0.3 mm or more will be provided between the through hole and stand-off part.

PCB Mounting

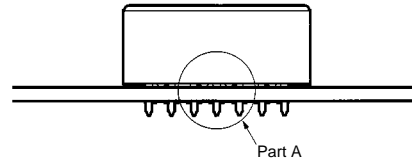

Cross-section of Part A

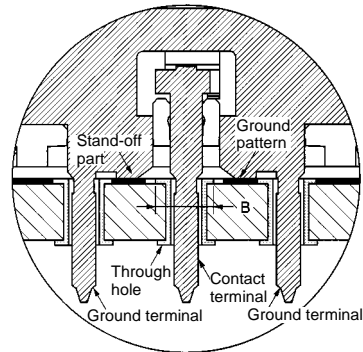

NOTE: DIMENSIONS SHOWN ARE IN MILLIMETERS. To convert millimeters to inches divide by 25.4.

OMRON[®]
OMRON ELECTRONICS, INC.
 One East Commerce Drive
 Schaumburg, IL 60173
1-800-55-OMRON

OMRON CANADA, INC.
 885 Milner Avenue
 Scarborough, Ontario M1B 5V8
416-286-6465