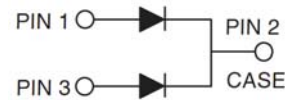

Dual Common Cathode Schottky Rectifier

FEATURES

- Low power loss, high efficiency
- Guardring for overvoltage protection
- High surge current capability
- Compliant to RoHS Directive 2011/65/EU and in accordance to WEEE 2002/96/EC
- Halogen-free according to IEC 61249-2-21 definition

TO-220AB

MECHANICAL DATA

Case: TO-220AB

Molding compound, UL flammability classification rating 94V-0

Base P/N with suffix "G" on packing code - halogen-free

Base P/N with prefix "H" on packing code - AEC-Q101 qualified

Terminal: Matte tin plated leads, solderable per JESD22-B102

Meet JESD 201 class 1A whisker test,

with prefix "H" on packing code meet JESD 201 class 2 whisker test

Polarity: As marked

Mounting torque: 5 in-lbs maximum

Weight: 1.88 g (approximately)

MAXIMUM RATINGS AND ELECTRICAL CHARACTERISTICS (T _A =25°C unless otherwise noted)										
PARAMETER	SYMBOL	MBR 1035 CT	MBR 1045 CT	MBR 1050 CT	MBR 1060 CT	MBR 1090 CT	MBR 10100 CT	MBR 10150 CT	MBR 10200 CT	UNIT
Maximum repetitive peak reverse voltage	V _{RRM}	35	45	50	60	90	100	150	200	V
Maximum RMS voltage	V _{RMS}	24	31	35	42	63	70	105	140	V
Maximum DC blocking voltage	V _{DC}	35	45	50	60	90	100	150	200	V
Maximum average forward rectified current	I _{F(AV)}	10								A
Peak repetitive forward current (Rated VR, Square Wave, 20KHz)	I _{FRM}	10								A
Peak forward surge current, 8.3 ms single half sine-wave superimposed on rated load	I _{FSM}	120								A
Peak repetitive reverse surge current (Note 1)	I _{RSM}	1	0.5						A	
Maximum instantaneous forward voltage (Note 2) I _F = 5 A, T _J =25°C I _F = 5 A, T _J =125°C I _F = 10 A, T _J =25°C I _F = 10 A, T _J =125°C	V _F	0.70 0.57 0.80 0.67	0.80 0.65 0.90 0.75		0.85 0.75 0.95 0.85		0.88 0.78 0.98 0.88		V	
Maximum reverse current @ rated VR T _J =25 °C T _J =125 °C	I _R	0.1								mA
		15	10	2	5					
Voltage rate of change (Rated V _R)	dV/dt	10000								V/μs
Typical thermal resistance	R _{θJC}	1.5								°C/W
Operating junction temperature range	T _J	- 55 to +150								°C
Storage temperature range	T _{STG}	- 55 to +150								°C

Note 1: tp = 2.0 μs, 1.0KHz

Note 2: Pulse test with PW=300μs, 1% duty cycle

ORDERING INFORMATION					
PART NO.	AEC-Q101 QUALIFIED	PACKING CODE	GREEN COMPOUND CODE	PACKAGE	PACKING
MBR10xxCT (Note 1)	Prefix "H"	C0	Suffix "G"	TO-220AB	50 / Tube

Note 1: "xx" defines voltage from 35V (MBR1035CT) to 200V (MBR10200CT)

EXAMPLE					
PREFERRED P/N	PART NO.	AEC-Q101 QUALIFIED	PACKING CODE	GREEN COMPOUND CODE	DESCRIPTION
MBR1060CT C0	MBR1060CT		C0		
MBR1060CT C0G	MBR1060CT		C0	G	Green compound
MBR1060CTHC0	MBR1060CT	H	C0		AEC-Q101 qualified

RATINGS AND CHARACTERISTICS CURVES

(TA=25°C unless otherwise noted)

FIG. 1- FORWARD CURRENT DERATING CURVE

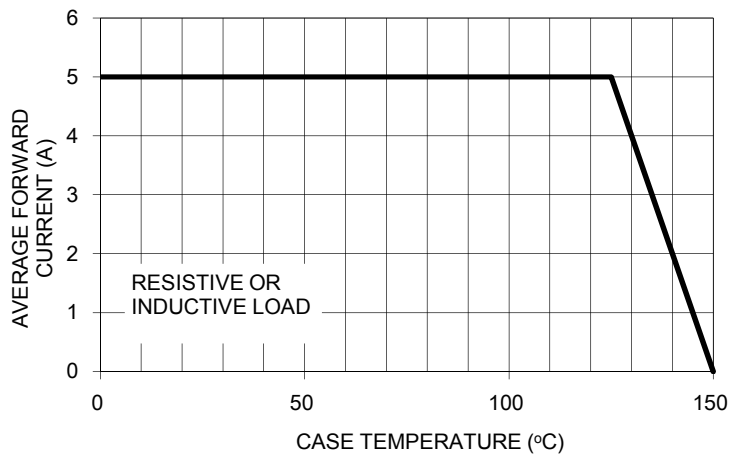

FIG. 2- MAXIMUM NON-REPETITIVE FORWARD SURGE CURRENT

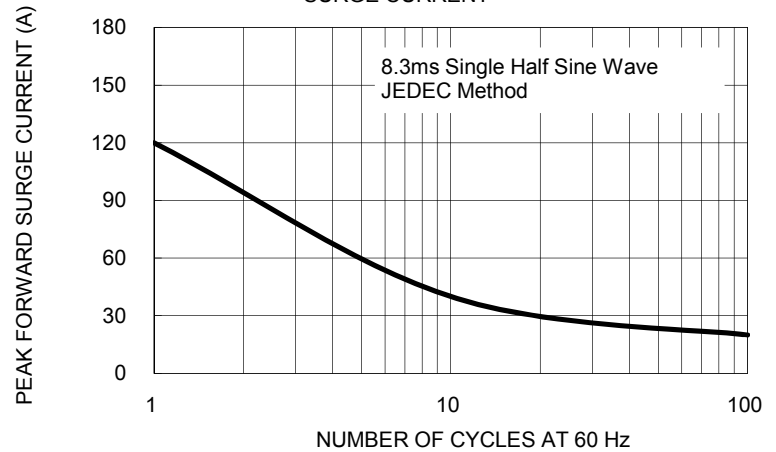

FIG. 3- TYPICAL FORWARD CHARACTERISTICS

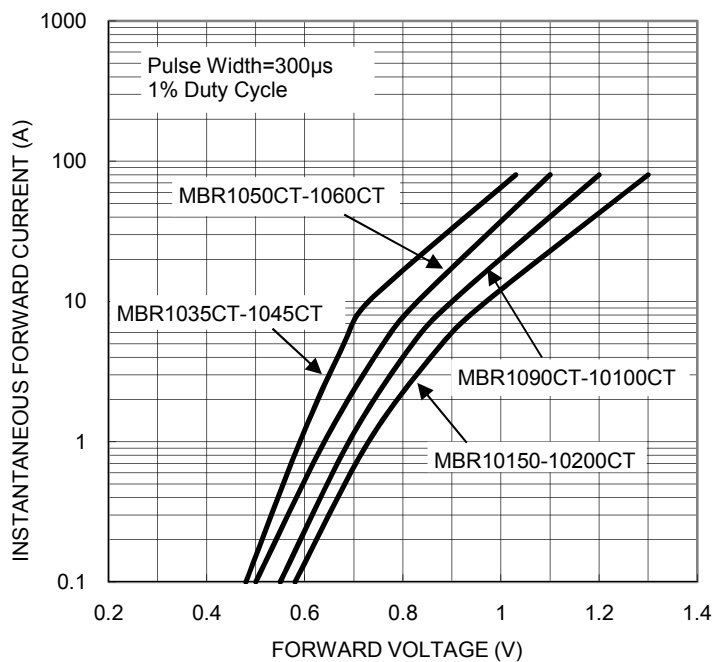

FIG. 4- TYPICAL REVERSE CHARACTERISTICS

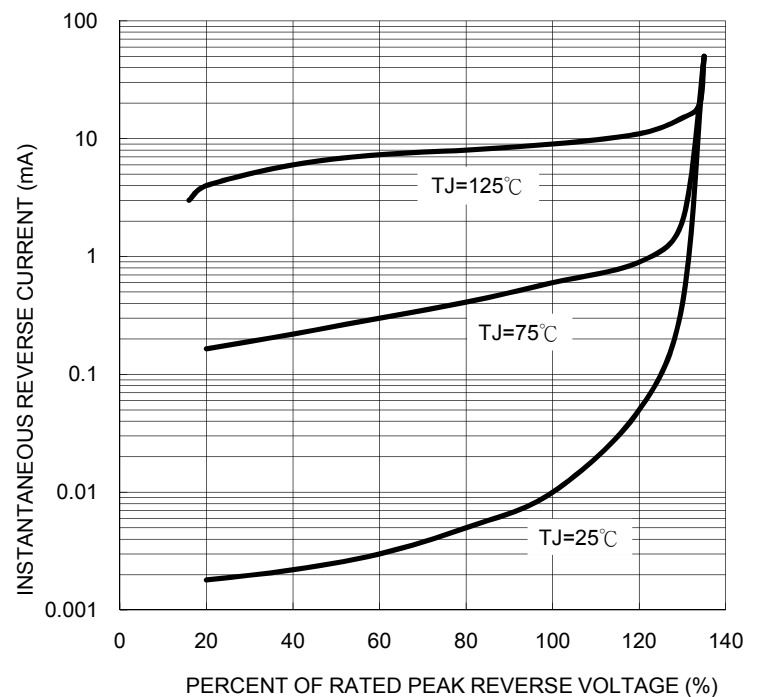

FIG. 5- TYPICAL JUNCTION CAPACITANCE

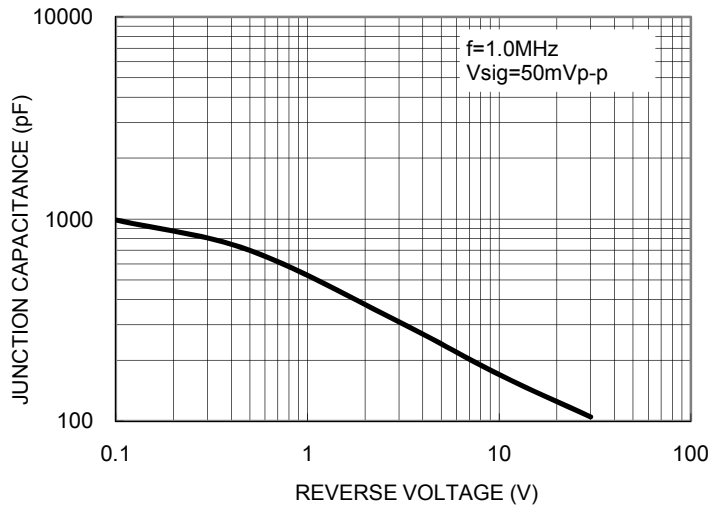
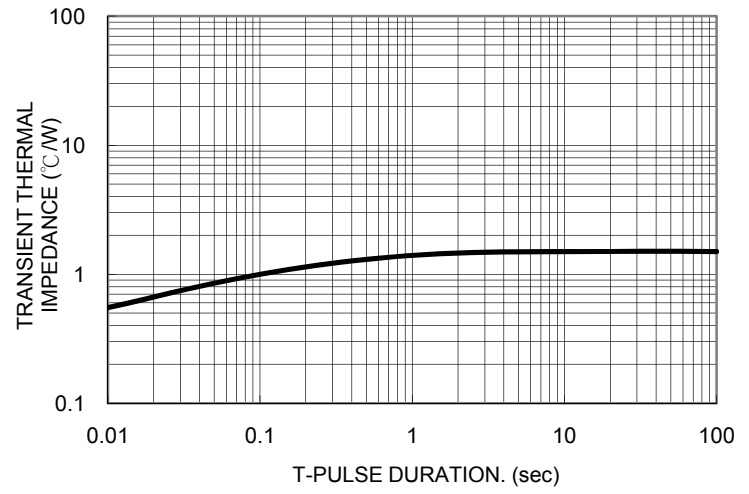
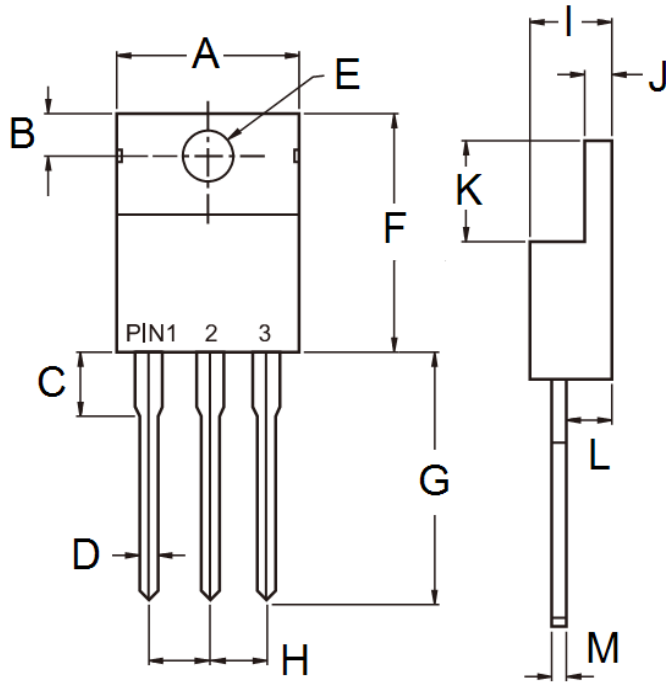

FIG. 6- TYPICAL TRANSIENT THERMAL CHARACTERISTICS PER LEG



PACKAGE OUTLINE DIMENSIONS



DIM.	Unit (mm)		Unit (inch)	
	Min	Max	Min	Max
A	-	10.50	-	0.413
B	2.62	3.44	0.103	0.135
C	2.80	4.20	0.110	0.165
D	0.68	0.94	0.027	0.037
E	3.54	4.00	0.139	0.157
F	14.60	16.00	0.575	0.630
G	13.19	14.79	0.519	0.582
H	2.41	2.67	0.095	0.105
I	4.42	4.76	0.174	0.187
J	1.14	1.40	0.045	0.055
K	5.84	6.86	0.230	0.270
L	2.20	2.80	0.087	0.110
M	0.35	0.64	0.014	0.025

MARKING DIAGRAM



- P/N = Marking Code
- G = Green Compound
- YWW = Date Code
- F = Factory Code

Notice

Specifications of the products displayed herein are subject to change without notice. TSC or anyone on its behalf, assumes no responsibility or liability for any errors inaccuracies.

Information contained herein is intended to provide a product description only. No license, express or implied, to any intellectual property rights is granted by this document. Except as provided in TSC's terms and conditions of sale for such products, TSC assumes no liability whatsoever, and disclaims any express or implied warranty, relating to sale and/or use of TSC products including liability or warranties relating to fitness for a particular purpose, merchantability, or infringement of any patent, copyright, or other intellectual property right.

The products shown herein are not designed for use in medical, life-saving, or life-sustaining applications. Customers using or selling these products for use in such applications do so at their own risk and agree to fully indemnify TSC for any damages resulting from such improper use or sale.